



**CORMORAN**

CATALOGUE 2024

**CORMORAN**

## Table of contents

<b>Reels</b> .....	<b>4-15</b>
Spinning reels .....	4-7
Feeder reels .....	8-9
Special reels .....	10
Sea fishing reels .....	11-12
Freespool reels .....	13-15
Spare spools .....	16-17
<b>Rods</b> .....	<b>18-41</b>
Spinning rods .....	22-27
Trout rods .....	27
Ruod accessories .....	27
Carp rods .....	28-29
Feeder rods .....	30-35, 38
Coarse rods .....	36-37, 39
Poles .....	39
Tele rods .....	39
Catfish rods .....	40
Sea fishing rods .....	41
<b>Supplies</b> .....	<b>42-122</b>
Braided lines .....	42-43
Monofilament lines .....	44
Spoons .....	45
Plugs .....	46-52
Spinners .....	53-54
Trout Spoons .....	55
Soft plastic lures .....	56-57
Coarse fishing supplies .....	58, 62-64
Hair Rigs .....	59-60
Sbirolinos .....	61
Glow sticks .....	65
Bait .....	67
Floats / Hooks / Swivel / Steel wires .....	68-77
Sinkers .....	78
Fishing tools / Smoking oven .....	79-85
Bite indicator .....	66, 86-90
Rod Pods .....	91-92
Rod rests .....	90-96
Nets / Landing nets .....	97-105
Tackle boxes .....	106-109
Bags .....	110-112
Holdalls .....	113-116
Unhooking mat .....	116
Chairs / Bedchairs .....	117-119
Umbrellas .....	119
Clothing .....	120-122

## Alphabetical index

<b>A</b>	
Aeration pumps .....	81
Assist hooks .....	77
<b>B</b>	
Backpacks .....	112
Bags .....	110-116
Bait boxes .....	107
Bait Former .....	61
Bait needles .....	80
Bait .....	67
Baitfish traps .....	97
Bedchairs .....	117
Bite indicators .....	66, 86-90
Booms .....	58
Braided lines .....	42-43
<b>C</b>	
Carp rods .....	28
Catfish reels .....	10
Catfish rods .....	40
Chairs .....	118-119
Chest waders .....	121-122
Clothing .....	120-122
Coarse rods .....	36-37, 39
Crimping pliers .....	79
<b>D</b>	
Depth finders .....	78
<b>E</b>	
Eel bells .....	66
Eel feeders .....	78
Electronic bite indicators .....	86-90
<b>F</b>	
Feeder reels .....	8-9
Feeder rods .....	30-35, 38
Filleting set .....	83-84
Fishing tools / Smoking oven .....	79-85
Float stoppers .....	62-64
Floats .....	68-69
Freespool reels .....	13-15
<b>G</b>	
Gloves .....	120
Glow sticks .....	65
Groundbait .....	67
<b>H</b>	
Hair Rigs .....	59-60
Headlamps .....	85
Holdalls .....	113-116
<b>K</b>	
Keep nets .....	97
Knife sets .....	83-84
Knives .....	82-84
<b>L</b>	
Landing net handles .....	104
Landing nets .....	97-105
Line connectors .....	74
Line stopper .....	63-64
Lines .....	42-44
Lure boxes .....	106-108
<b>M</b>	
Monofilament lines .....	44
<b>N</b>	
Neoprene clothing .....	120-122
<b>P</b>	
Pliers .....	79, 82
Plugs .....	46-52
Priest .....	80
<b>R</b>	
Ready-made rigs .....	68
Reels .....	4-15
Rigbox .....	58
Rod bags .....	113-116
Rod holders .....	91-96
Rod pods .....	91-92
Rod rests .....	90-96
Rod supplies .....	27
Rods .....	18-41
<b>S</b>	
Sbirolinos .....	61
Scales .....	81, 85
Sea fishing reel .....	11-12
Sea fishing rods .....	41
Sea trout landing net .....	98
Sinkers .....	78
Smoking oven .....	81
Snaps .....	73-74
Snelled hooks .....	70-72
Soft plastic lures .....	56-57
Spare spools .....	16-17
Spinners .....	53-54
Spinning reels .....	4-7
Spinning rods .....	22-27
Splitring pliers .....	82
Spoons .....	45
Swivel .....	73-74
<b>T</b>	
Tackle boxes .....	107-109
Thermo boots .....	120
Tripod .....	95-96
Trout Spoons .....	55
<b>U</b>	
Umbrella tent .....	119
Umbrellas .....	119
Unhooking mats .....	116
Unhooking pliers .....	82
<b>W</b>	
Wading boots .....	121-122
Wire leaders .....	75-77

A scenic sunset over a body of water. The sun is low on the horizon, creating a bright, golden glow that reflects on the water's surface. In the foreground, there are silhouettes of reeds and other aquatic plants. On the right side, a dark, curved handle or part of a boat is visible. The overall atmosphere is peaceful and serene.

**PROGRAM**

**2023/2024**





Cross Wrap Cross Water 5PIF

## CROSS WATER 5PIF

### SPINNING REEL

The Cross Water 5PIF offers an outstanding price-performance ratio and – depending on the reel size – is designed for permanent reliable application at freshwater fishing for zander, pike, perch or trout but can also be used for general coarse fishing.

Thanks to the power gear and the accurate cross wrap with X-Wind line lay the Cross Water 5PIF is also perfectly suited for the use of thin braided lines. The line lay is exemplary while the convenient running cares for permanent fishing fun.

- 4 ball bearings
- Power gear
- Infinite Anti-Reverse®, stageless
- Finely adjustable spool drag
- X-Wind cross wrap
- S-Stroke oscillation system
- Aluminum longcast spool
- PowerBail
- Large anti-twist line roller
- Longlife bail spring
- CNC-machined aluminum handle
- Soft-touch handle knob

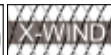

Art.-No.	Size	BB total	Capacity m/mm	Ratio	Retrieval cm	Weight g
12-59050	500	4	140/0.14	5.1:1	61	180
12-59100	1000	4	240/0.16	5.1:1	64	185
12-59200	2000	4	200/0.20	5.1:1	69	225
12-59250	2500	4	250/0.20	5.1:1	74	245
12-59300	3000	4	200/0.25	5.1:1	74	250



## SPOON TROUT 8PIF

### TROUT SPINNING REEL

Classic design meets latest technology. Size and line capacity are perfectly matched for the requirements of light trout fishing. The compact combination of body and rotor as well as the super-shallow and perfectly dimensioned spool form a harmonic unit and can be perfectly used with any type of Trout Spoon rod. Designed for the use of thin mono or braided lines the Spoon Trout 8PIF allows also casting of smallest spoons to long distances thanks to the X-Wind cross wrap. The 7 ball bearings and the accurately manufactured components care for a silky-smooth running and allow convenient application at fishing.



Cross Wrap Spoon Trout 8PIF

- 7 ball bearings
- Infinite Anti-Reverse®, stageless
- Finely adjustable spool drag
- X-Wind cross wrap
- S-Stroke oscillation system
- Aluminum longcast spool
- PowerBail
- Large anti-twist line roller
- Longlife bail spring
- CNC-machined aluminum handle
- Soft-touch handle knob



Art.-No.	Size	BB total	Capacity m/mm	Ratio	Retrieval cm	Weight g
12-58150	1500	7	140/0.14	5.1:1	61	175



## SPOON TROUT 4PIF

### TROUT SPINNING REEL

Expectations on light trout reels can't be met more sovereignly within this price range. This reel catches the attention of every angler at first glance. The sporty and dynamic silhouette and the compact unit of housing and rotor as well as the perfectly dimensioned spool would excel also much pricier reels. Designed for the use of slim mono and braided lines this reel allows convenient casting also of smallest spoons thanks to the perfect X-Wind cross wrap.



Cross Wrap Spoon Trout 4PiF

- 3 ball bearings
- Infinite Anti-Reverse®, stageless
- Finely adjustable spool drag
- X-Wind cross wrap
- S-Stroke oscillation system
- Aluminum longcast spool
- PowerBail
- Large anti-twist line roller
- Longlife bail spring
- Aluminum handle
- Soft-touch handle knob

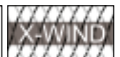

Art.-No.	Size	BB total	Capacity m/mm	Ratio	Retrieval cm	Weight g
12-44150	1500	3	140/0.14	5.1:1	61	175





## SPORTLINE 2PIF

### SPINNING REEL

Developing reels, that are excelled by their excellent price-performance ratio has been the goal of CORMORAN ever since. Of course this reel is no exception. This reliable companion unites robustness with low weight and a smooth running. And all that at an unbeatable price.

- 1 ball bearing
- Infinite Anti-Reverse®, stageless
- Finely adjustable spool drag
- X-Wind cross wrap
- S-Stroke oscillation system
- ABS nylon longcast spool
- PowerBail
- Large anti-twist line roller
- Longlife bail spring
- Aluminum handle
- Soft-touch handle knob



Art.-No.	Size	BB total	Capacity m/mm	Ratio	Retrieval cm	Weight g
12-22250	2500	1	180/0.25	5.1:1	70	220



## VEYCOR FEEDER 4PIF

### LONGCAST FEEDER REEL

Compact and ultra-modern longcast reel for feeder fishing as well as long range carp fishing or heavy spin fishing with slim braided lines.

Equipped with especially designed aluminum spool, which features a large diameter and allows excellent casting distances. Equipped with 2 metal feeder line clips. The discreet design and the compact unit of drag, rotor and spool characterizes the appearance of this reel. The X-Wind cross wrap is operated via the S-Stroke system, which is in charge for the even line lay and therefore enables extraordinarily long casting distances. The QD fast drag with drag discs made of carbon can be switched from completely loose to fully operating within one turn. The high power transmission of the VeyCor Feeder 4PIF is the solid foundation for quick und secure fights with the fish.



Only one turn between run and fun!

- 3 ball bearings
- Infinite Anti-Reverse®, stageless
- Fast Drag front drag
- Carbon drag discs
- X-Wind cross wrap
- S-Stroke oscillation system
- Aluminum longcast spool
- „Spring-Type“ line clip (double)
- PowerBail
- Large anti-twist line roller
- Longlife bail spring
- Aluminum handle
- Large soft-touch handle knob



Art.-No.	Size	BB total	Capacity m/mm	Ratio	Retrieval cm	Weight g
14-40600	6000	3	240/0.20	5.5:1	107	440



**VEYCOR FEEDER 5PIF**

FEEDER REEL

Today carbon fiber feeder rods are handier and more lightweight than ever before. But nevertheless, they have to be robust and tough. To create an appropriate partner for these modern feeder rods we developed the VeyCor Feeder 5PIF 5000, which is based on the same principles: lightweight, highly robust and affordable. At the VeyCor Feeder 5PIF we had a particular focus at the drag: also this reel features our new Brake Block drag system with „QD“ Fast Drag function, since you fully have to rely on your drag when setting the hook at fishing in strong currents. The high power transmission supports the angler at ending the fight with the fish quickly and allows the fisherman to lead the fish securely to the landing net. With a line capacity of 230m/0.25mm The VeyCor Feeder 5PIF 5000 has the proper size for all types of feeder fishing, including heavy feeder fishing at large rivers. Equipped with supersized 2-times anodized aluminum spool with 2 large lineclips and fast snap aluminum handle.

- 4 ball bearings
- Infinite Anti-Reverse®, stageless
- Brake Block drag system
- Fast Drag front drag
- X-Wind cross wrap
- S-Stroke oscillation system
- CNC-machined aluminum longcast spool
- „Spring-Type“ line clip (double)
- PowerBail
- Large anti-twist line roller
- Longlife bail spring
- Aluminum fast snap handle
- Soft-touch handle knob



Only one turn between run and fun!



Brake Block drag system

INFINITE  
ANTI-REVERSE SYSTEM

**S-Stroke**  
OSCILLATION SYSTEM

CNC ALUMINIUM  
SPOOL

**X-WIND**  
CROSS WRAP

LONGCAST  
CONCEPT

**QD**  
FAST DRAG

**ANTI-TWIST**  
LINE ROLLER

**Brake Block drag system**

Art.-No.	Size	BB total	Capacity m/mm	Ratio	Retrieval cm	Weight g
14-51500	5000	4	230/0.25	5.5:1	95	375



## BIG CAT 5PIF

### CATFISH REEL

The Big Cat 5PIF catfish reel combines high toughness and winding power with a smooth and well-balanced running as well as high line capacity. The strong and thick-walled body cares for a safe housing of the power gear and allows a high power transmission at the fight with large catfish.

The particularly developed CNC-cut aluminum spool features a high line capacity and is also suited for the use of strong braided lines.

- 4 ball bearings
- Infinite Anti-Reverse®, stageless
- Extra strong spool drag
- X-Wind cross wrap
- S-Stroke oscillation system
- CNC-machined aluminum longcast spool
- PowerBail
- Large anti-twist line roller
- Longlife bail spring
- CNC-machined aluminum handle
- Soft-touch handle knob

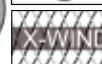

Art.-No.	Size	BB total	Capacity m/mm	Ratio	Retrieval cm	Weight g
14-50800	8000	4	460/0.40	4.3:1	97	695



Cross Wrap Seacor Power Pilk 5PIF

## SEACOR POWER PILK 5PIF

### SALTWATER SPINNING REEL

When your expectations on a jigging reel are predominantly focused on supreme quality and reliable performance, the Seacor Power Pilk 5PIF is just the right choice. Designed for tough application and equipped with a real power gear, which is operated via the strong CNC-cut aluminum handle, you don't have to fear the fight with even large specimen. This reel further features our novel Brake Block drag system, 4 „NCBB“ steel ball bearings, a super-strong aluminum long-cast spool and our S-Stroke system, which guarantees a perfect line lay. Also the other components – like the strong bail or the invincible reel body – ensure reliable functioning and a long lifespan.



Brake Block drag system

- 4 NCBB ball bearings
- Power gear
- Infinite Anti-Reverse®, stageless
- Brake Block drag system
- X-Wind cross wrap
- S-Stroke oscillation system
- Aluminum longcast spool
- PowerBail
- Large anti-twist line roller
- Longlife bail spring
- CNC-machined aluminum handle
- Soft-touch handle knob

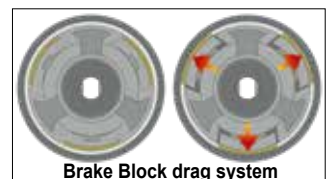
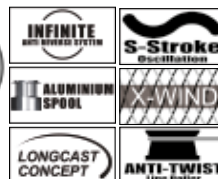

Brake Block drag system

Art.-No.	Size	BB NCBB	BB total	Capacity m/mm	Ratio	Retrieval cm	Weight g
14-56500	5000	4	4	320/0.35	5.2:1	95	380



Cross Wrap Seacor Pilk 5PiF

## SEACOR PILK 5PIF

### SALTWATER SPINNING REEL

State-of-the-art saltwater spinning reel with particularly designed spool, which instantly meets the eye thanks to its large diameter and is famous for its outstanding casting properties. Thanks to the S-Stroke system an even line lay is ensured, regardless if monofilament or braided lines are used.

This reel is perfectly applicable as light jigging reel or for spin fishing at the sea. All components are highly robust, since even light jigging is quite demanding for fishing reels.

This reel further features our novel Brake Block drag system, 4 „NCBB“ steel ball bearings, a super-strong aluminum long-cast spool and our S-Stroke system, which guarantees a perfect line lay. Also the other components – like the strong bail or the invincible reel body – ensure reliable functioning and a long lifespan.



Brake Block drag system

- 4 NCBB ball bearings
- Power gear
- Infinite Anti-Reverse®, stageless
- Brake Block drag system
- X-Wind cross wrap
- S-Stroke oscillation system
- Aluminum longcast spool
- PowerBail
- Large anti-twist line roller
- Longlife bail spring
- CNC-machined aluminum handle
- Soft-touch handle knob

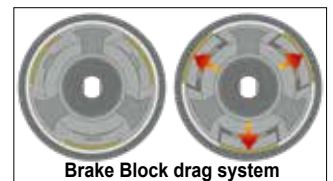
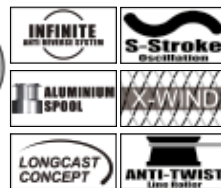

Brake Block drag system

Art.-No.	Size	BB NCBB	BB total	Capacity m/mm	Ratio	Retrieval cm	Weight g
14-55400	4000	4	4	270/0.30	5.5:1	95	370



Cross Wrap VeyCor BR 7PiF

## VEYCOR BR 7PIF

### FREESPOOL REEL

The VeyCor BR 7PiF is an outstanding free spool reel, which is excelled by its remarkably smooth running and the reliably working free spool system that is a common characteristic for CORMORAN. It works accurately, is adjustable over a broad range and allows also completely free drawing of the line. The small sizes are perfectly suited for common ground fishing for smaller fish as well as for fishing for barbels and trouts. Thanks to the free spool system they can also conveniently be applied for match fishing. The larger models are the right choice for fishing for carp or feeder fishing in strong currents. Equipped with a light t-tone aluminum spool and a sturdy cnc-cut aluminum handle.



- 6 ball bearings
- Infinite Anti-Reverse®, stageless
- Finely adjustable spool drag
- Automatic free spool system, adjustable
- X-Wind cross wrap
- S-Stroke oscillation system
- Aluminum longcast spool
- PowerBail
- Large anti-twist line roller
- Longlife bail spring
- CNC-machined aluminum handle
- Soft-touch handle knob

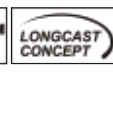

Art.-No.	Size	BB total	Capacity m/mm	Ratio	Retrieval cm	Weight g
19-74300	3000	6	200/0.25	5.1:1	73	330
19-74400	4000	6	240/0.28	5.1:1	73	350
19-74500	5000	6	350/0.30	5.5:1	97	470
19-74600	6000	6	400/0.32	5.5:1	110	495



## VEYCOR BR 4PiF

### FREESPOOL REEL

The smaller models of the VeyCor BR 4PiF are the proper choice for common coarse fishing for all smaller target fish as well as for fishing for barbels and trouts. Due to its free spool system it can be also conveniently applied for match fishing. The larger models of this series are designed for heavy fishing for carps or for fishing at strong currents as well as for feeder fishing.

The VeyCor BR 4PiF reels are equipped with a lightweight two tone aluminum spool. The free spool system works precisely and can be adjusted over a broad range, allowing even to set the system to zero resistance.



Cross Wrap VeyCor BR 4PiF

- 3 ball bearings
- Infinite Anti-Reverse®, stageless
- Finely adjustable spool drag
- Automatic free spool system, adjustable
- X-Wind cross wrap
- S-Stroke oscillation system
- Aluminum longcast spool
- PowerBail
- Large anti-twist line roller
- Longlife bail spring
- CNC-machined aluminum handle
- Soft-touch handle knob



Art.-No.	Size	BB total	Capacity m/mm	Ratio	Retrieval cm	Weight g
19-46300	3000	3	200/0.25	5.1:1	73	330
19-46400	4000	3	240/0.28	5.1:1	73	350
19-46500	5000	3	350/0.30	5.1:1	97	470
19-46600	6000	3	400/0.32	5.1:1	110	505





**CORMAXX BR 3PIF**

**FREESPOOL REEL**

Beautiful and light free spool reels with convincing price-performance ratio. The freespool system works precisely and can be adjusted over a wide range, allowing also a completely free drawing of the line. The gearing works reliably and round with hardly noteworthy resistance at the handle – a real exception within this price category.

- 2 ball bearings
- Infinite Anti-Reverse®, stageless
- Automatic free spool system, adjustable
- X-Wind cross wrap
- S-Stroke oscillation system
- 2-tone aluminum spool
- PowerBail
- Large anti-twist line roller
- Aluminum handle
- Soft-touch handle knob

Equipped with premium 2-tone aluminum spool and a line-sparing anti-twist line roller.



Art.-No.	Size	BB total	Capacity m/mm	Ratio	Retrieval cm	Weight g
19-81200	2000	2	130/0.25	5.1:1	67	280
19-81250	2500	2	180/0.25	5.1:1	73	300
19-81300	3000	2	210/0.28	5.1:1	85	380
19-81350	3500	2	250/0.30	5.1:1	85	385
19-81400	4000	2	290/0.30	5.1:1	85	390



## Spare spools for Spinning Reels

### Spare Spools for Cross Water 5PiF

Art.-No.	Matching with Reel(s) Model(s)	Matching with Reel(s) Art.-No.	Matching with Reel(s) Size	Material Spare Spool
12-9959050	Cross Water 5PiF	12-59050	500	aluminum
12-9959100	Cross Water 5PiF	12-59100	1000	aluminum
12-9959200	Cross Water 5PiF	12-59200	2000	aluminum
12-9959250	Cross Water 5PiF	12-59250	2500	aluminum
12-9959300	Cross Water 5PiF	12-59300	3000	aluminum

### Spare Spools for VeyCor Feeder 5PiF

Art.-No.	Matching with Reel(s) Model(s)	Matching with Reel(s) Art.-No.	Matching with Reel(s) Size	Material Spare Spool
14-9951500	VeyCor Feeder 5PiF	14-51500	5000	aluminum

### Spare Spools for VeyCor Feeder 4PiF

Art.-No.	Matching with Reel(s) Model(s)	Matching with Reel(s) Art.-No.	Matching with Reel(s) Size	Material Spare Spool
14-9940600	VeyCor Feeder 4PiF	14-40600	6000	aluminum

### Spare Spools for Spoon Trout 4PiF

Art.-No.	Matching with Reel(s) Model(s)	Matching with Reel(s) Art.-No.	Matching with Reel(s) Size	Material Spare Spool
12-9944150	Spoon Trout 4PiF	12-44150	1500	aluminum

### Spare Spools for Spoon Trout 8PiF

Art.-No.	Matching with Reel(s) Model(s)	Matching with Reel(s) Art.-No.	Matching with Reel(s) Size	Material Spare Spool
12-9958150	Spoon Trout 8PiF	12-58150	1500	aluminum

### Spare Spools for Big Cat 5PiF

Art.-No.	Matching with Reel(s) Model(s)	Matching with Reel(s) Art.-No.	Matching with Reel(s) Size	Material Spare Spool
14-9950800	Big Cat 5PiF	14-50800	8000	aluminum

### Spare Spools for Seacor Power Pilk 5PiF

Art.-No.	Matching with Reel(s) Model(s)	Matching with Reel(s) Art.-No.	Matching with Reel(s) Size	Material Spare Spool
14-9956500	Seacor Power Pilk 5PiF	14-56500	5000	aluminum



**Spare spools for Spinning Reels**

**Spare Spools for Seacor Pilk 5PiF**

Art.-No.	Matching with Reel(s) Model(s)	Matching with Reel(s) Art.-No.	Matching with Reel(s) Size	Material Spare Spool
14-9955400	Seacor Pilk 5PiF	14-55400	4000	aluminum

**Spare Spools for VeyCor BR 4PiF**

Art.-No.	Matching with Reel(s) Model(s)	Matching with Reel(s) Art.-No.	Matching with Reel(s) Size	Material Spare Spool
19-9946250	VeyCor BR 4PiF	19-46250	2500	aluminum
19-9946300	VeyCor BR 4PiF	19-46300	3000	aluminum
19-9946400	VeyCor BR 4PiF	19-46400	4000	aluminum
19-9946500	VeyCor BR 4PiF	19-46500	5000	aluminum
19-9946600	VeyCor BR 4PiF	19-46600	6000	aluminum

**Spare spools for Free Spool Reels**

**Spare Spools for VeyCor BR 7PiF**

Art.-No.	Matching with Reel(s) Model(s)	Matching with Reel(s) Art.-No.	Matching with Reel(s) Size	Material Spare Spool
19-9974250	VeyCor BR 7PiF	19-74250	2500	aluminum
19-9974300	VeyCor BR 7PiF	19-74300	3000	aluminum
19-9974400	VeyCor BR 7PiF	19-74400	4000	aluminum
19-9974500	VeyCor BR 7PiF	19-74500	5000	aluminum
19-9974600	VeyCor BR 7PiF	19-74600	6000	aluminum

**Spare Spools for Cormaxx BR 3PiF**

Art.-No.	Matching with Reel(s) Model(s)	Matching with Reel(s) Art.-No.	Matching with Reel(s) Size	Material Spare Spool
19-9981200	Cormaxx BR 3PiF	19-81200	2000	aluminum
19-9981250	Cormaxx BR 3PiF	19-81250	2500	aluminum
19-9981300	Cormaxx BR 3PiF	19-81300	3000	aluminum
19-9981350	Cormaxx BR 3PiF	19-81350	3500	aluminum
19-9981400	Cormaxx BR 3PiF	19-81400	4000	aluminum

# RODS 2023/2024



## THE FOUNDATIONS OF OUR ROD DESIGN

The design of our spin and predator rods is subject to strictly defined principles, which are the basis for all rod series. Each rod model is signed considering its action and corresponding bending curve and considering its power and bending resistance. A rod isn't only marked by its action or the bending resistance by their own but by the combination of both substantial characteristics.

### Action & Bending Curve

Depending on the demand, all of our rods can be allocated to a strictly defined action type. Thus rods with an extra-fast **A** action are extremely fast and very sensitive for long and precise casts and to recognize every lure movement in the handle section. The backbone is stiff and powerful – but with this kind of action these rods are not that easy to handle during the fight compared to rods with a **B** or **C** action, which buffer and absorb more. The ones with **D** or **E** action are perfect fighting rods, but in return they offer less long and precise casts and the backbone is relatively soft and less powerful. Perfect for uncomplicated lures, but for more demanding ones, a **A** or **B** actioned rod is the better choice. Rods with these kinds of action usually need carbon fiber material with more elasticity than rods with **C** or **D** action and thus are more expensive. Our **Jiggerspin** rods with **AB** action represent an exception. They perfectly combine the characteristics of an **A** and a **B** action and are always reliable during the fight and somewhat more absorbing than rods with a single **A** action. The Flex point on a Jiggerspin rod is more flexible and adapts according to the strain.

### Power & Bending Resistance

This diagram illustrates all classes of power and stiffness with according casting weights (all tested with the same weight – the number “5” is a classification number, no kg specification). Nevertheless the range is somewhat broader than illustrated – thus in individual cases a rod with power and stiffness level L can also have a casting weight of up to 28g.

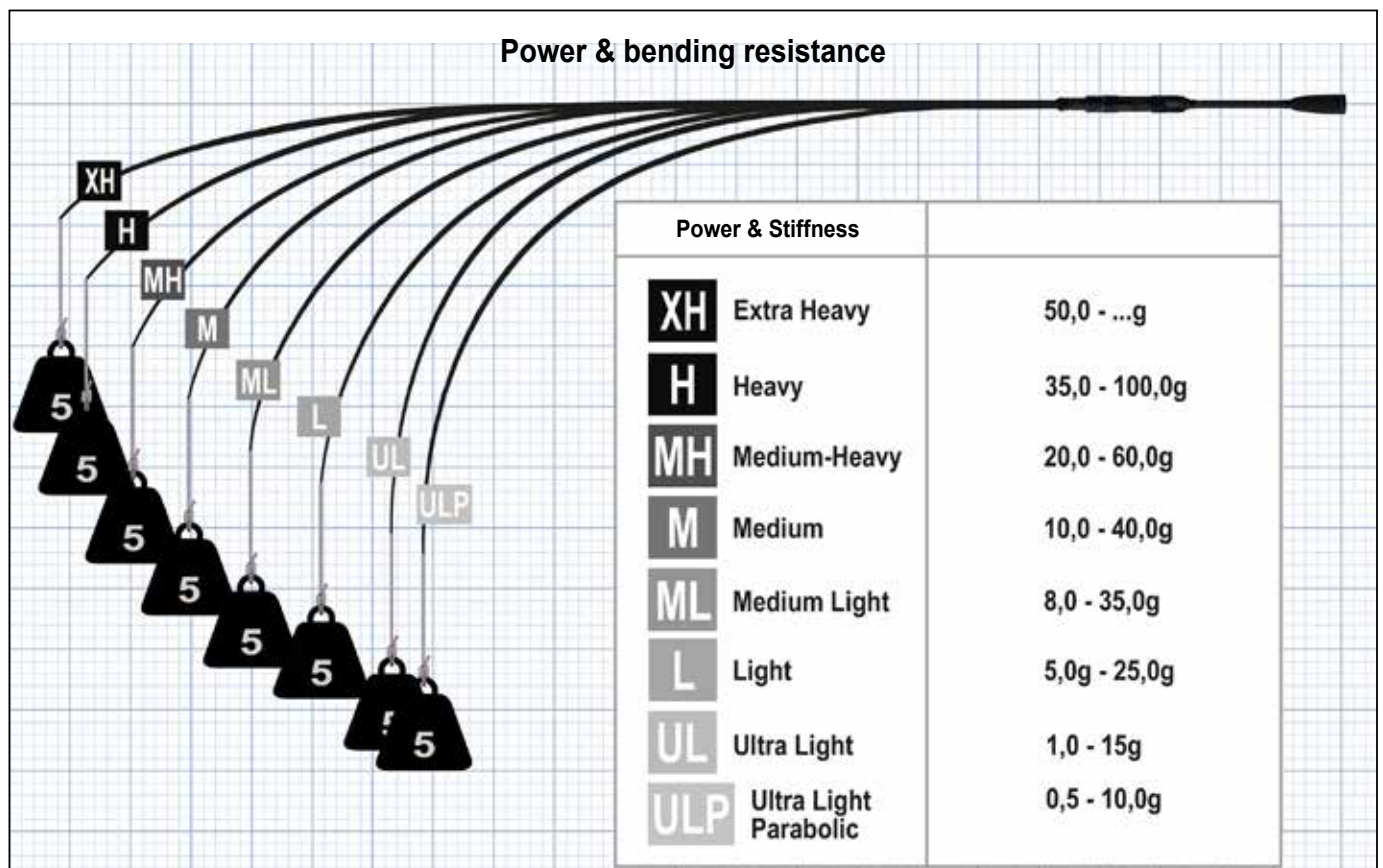
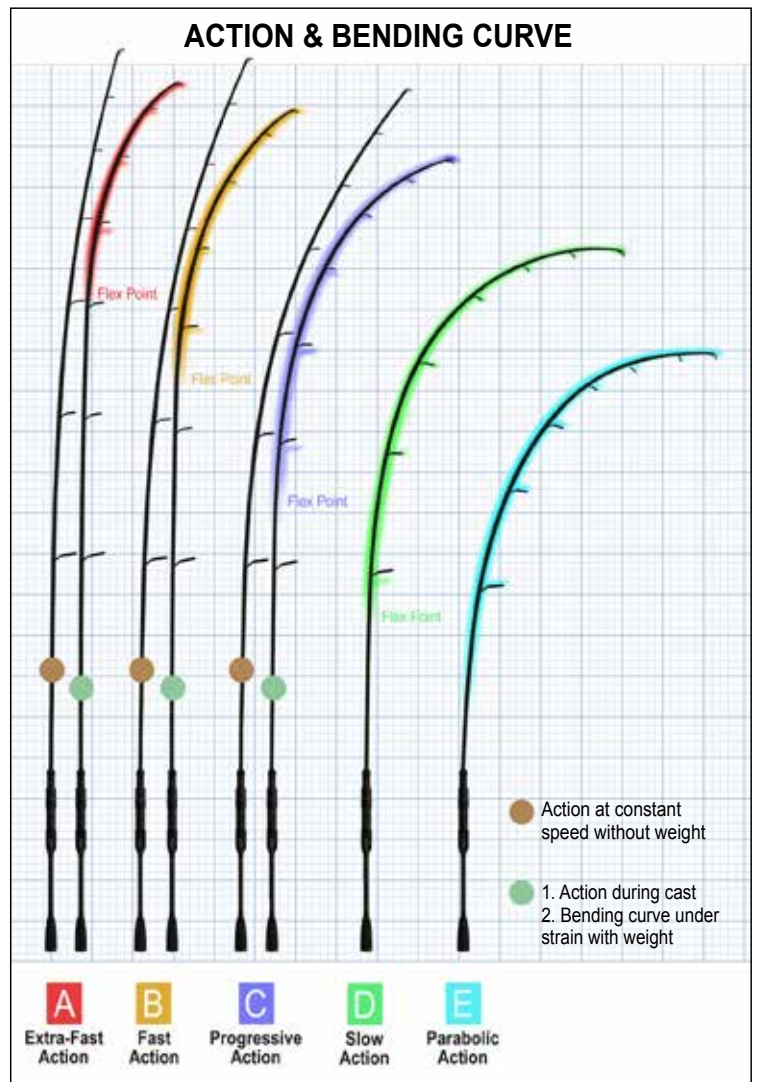

# RODS

Considering the power & stiffness diagrams of different rods in more detail, you can see the bending resistance under increasing weight. **(the weights are listed in classification numbers, not in kg).** These diagrams do not consider the different action types but only the bending resistance.

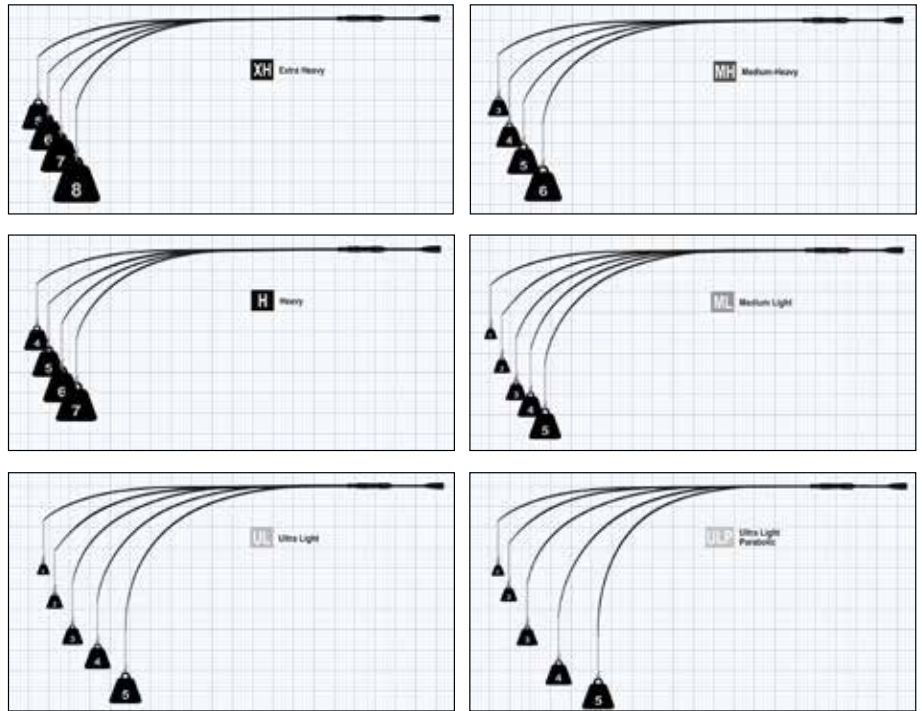

Considering the action & bending curve diagrams in more detail, you can see the bending resistances of differently stiff rods with the same action number. **(all tested with the same weight – the number “5” is a classification number, no kg specification).** To make it easier, only rods with **ML-H** characteristics are depicted – of course there are also rods with **A** action among **L** or **UL** models.

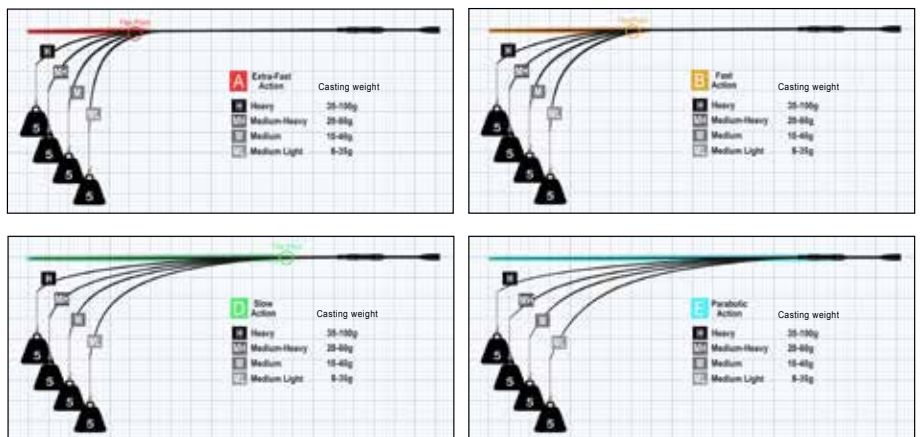

Considering particular rods, the combined diagrams of action & bending curve and power & bending resistance look like below **(the weights are listed in classification numbers, not in kg)**

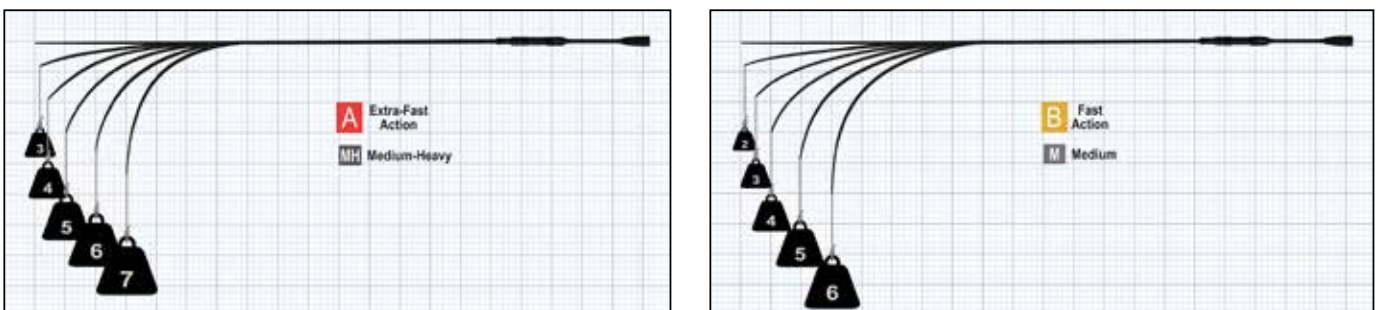

A rod's bending curve with ultra-fast **A** action in a **MH** medium-heavy version under different weights is shown below. The range of the casting weight is 20-60g. This kind of rod is powerful with a strong backbone and an extremely fast, very sensitive tip, which perfectly transmits the lure's action to the handle section. With this kind of rod long, precise casts and a fast, instantaneous setting of the hook are guaranteed. The resilience is great. But be cautious during the fight, especially in combination with braided lines – such a rod isn't absorbing that much and thus facilitates losses during too forced fights. An absorbing shockleader can help. This kind of rod is perfect for sophisticated lures, which need precise presentation.

A rod's bending curve with fast **B** action in a **M** medium version under different weights is shown below. The range of the casting weight is 10-40g. This kind of rod is powerful with a strong backbone and a sensitive tip, which leads the lures movements directly to the handle section. With this kind of rod, long and precise casts as well as a fast, instantaneous setting of the hook are guaranteed. The resilience usually is very fast. During the fight, such a rod is much less problematic than rod with action **A**. This kind of rod is perfectly made for all lures whose movements you want to feel in the handle section. Also cautious bites are indicated reliably with these rods.

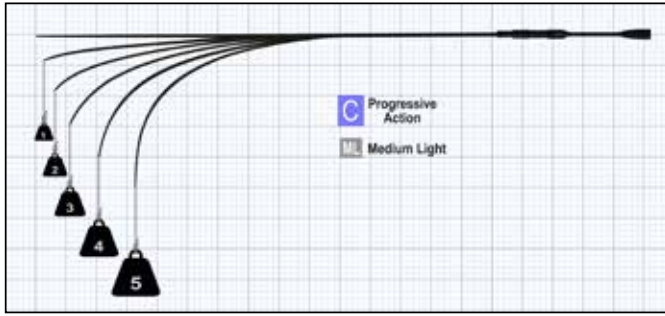

A rod's bending curve with progressive **C** action in a **ML** medium-light version loaded with different weights is shown below. The range of the casting weight is 8-35g. This kind of rod is very unproblematical regarding nearly all fields of application and does its job unexcitedly. It is a good choice for casual anglers and beginners fishing with small to medium lures. For bigger lures the **M** version with casting weights 10-40g or the **MH** version with 20-60g are the best choice. For a less experienced angler especially the fight with the fish is much easier with this kind of rod than with a faster rod of the **B** or even **A** type.

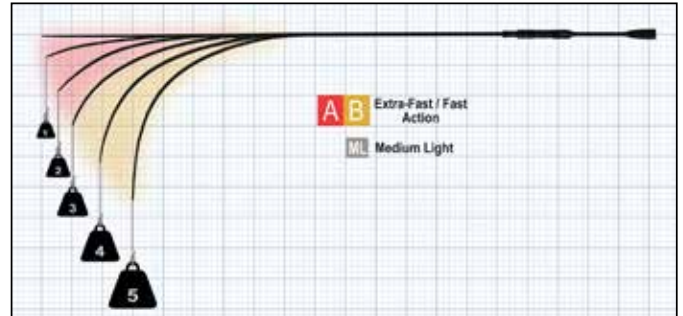

A jiggerspin rod's bending curve with special **AB** action in a **ML** medium-light version under different weights is shown below. The range of the casting weight is about 8-35g. A jiggerspin rod is very special and the right choice for plenty fields of application. The Flex Point (bending point of the blank under strain) of a jiggerspin rod adapts according to the strain. When presenting a difficult lure, the very fast tip transmits movements up to the handle section. During the cast and the fight, the Flex Point is accommodating to the **B** position. The jiggerspin rod is much more flexible within these tasks than a rod with a single **A** action. Our jiggerspin rods in **L** version with casting weights up to 28g are also very popular.

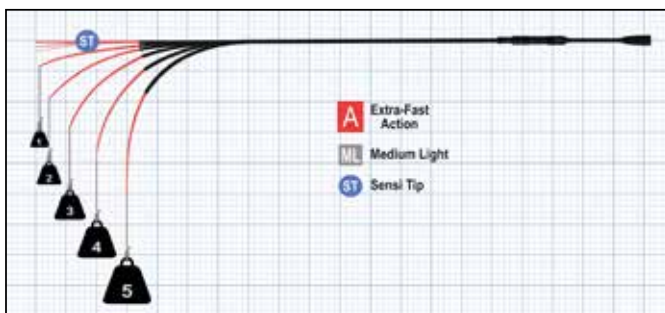

A rod's bending curve with extra-fast **A** action in a **ML** medium-light version and a **ST** solid carbon fiber tip under different weights is shown below. The range of the casting weight is 8-35g. To be satisfying the expectations, this kind of rod can only be realized with a High Modulus carbon fiber material to enable a great, ultra-fast tip action. It is marked by a powerful backbone and an extremely fast, sensitive solid carbon fiber tip, with reliably indicates even softest bites. Long and precise casts as well as a fast, instantaneous hooking are guaranteed. The resilience is fast. During forced fights with braided lines, losses can be elevated. An absorbing shockleader is often necessary. The **L**-Light category of this rod type is perfectly suited for sensitive finesse fishing with small plastic lures and jigs for perch, zander and trout. The **UL**-Ultralight category of this rod type is perfectly suited for highly sensitive finesse fishing with small and smallest lures for trout, perch and zander.

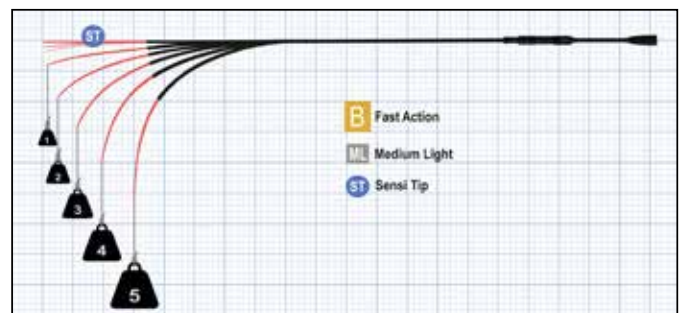

A rod's bending curve with fast **B** action in a **ML** medium-light version and a **ST** solid carbon fiber tip under different weights is shown below. The range of the casting weight is 8-35g. This type of rod is a supreme example for a jigging rod for perch, zander and trout with small plastic lures and jig, for a dropshot rod and for a natural bait rod for perch. The solid carbon fiber tip is extremely sensitive and detects also softest bites. Despite its strong backbone, such a rod is very unproblematical during the fight and does its job in all fields of application as expected. The **L**-Light category of this rod type is perfectly suited for sensitive fishing with small plastic lures and jigs for perch, zander and trout and for fishing with Texas and Carolina rig. The **UL**-Ultralight category of this rod type is perfectly suited for sensitive fishing with small and smallest lures for trout, perch and zander.

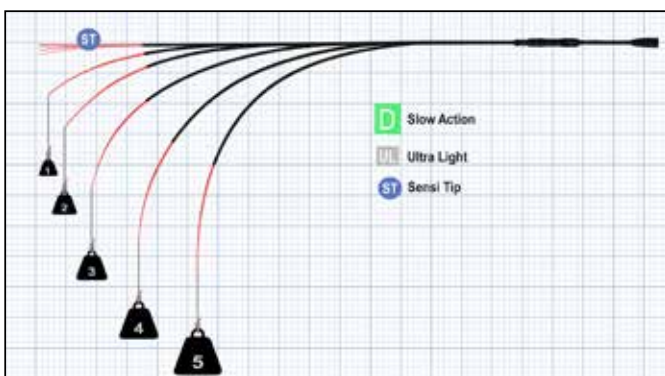

A rod's bending curve with slow **D** action in an **UL** ultra-light version and a **ST** solid carbon fiber tip under different weights is shown below. The range of the casting weight is 1-15g. This kind of rod is perfectly matching for fishing with undemanding lures as small spoons etc. for trout or perch in small waters over short distances. The solid carbon fiber tip is extremely sensitive and indicates also softest bites. The power reserves are limited but a fight with this kind of rod is very special.

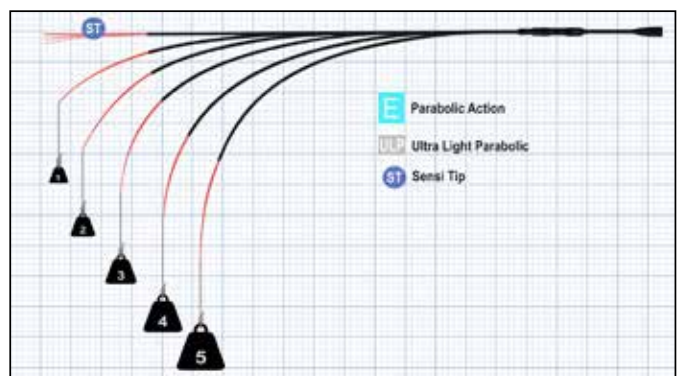

A rod's bending curve with parabolic **E** action in an **ULP** ultra-light parabolic version and a **ST** solid carbon fiber tip under different weights is shown below. The range of the casting weight is about 0.5-10g. This type is the ultimate choice for fishing with mini-spoons within trout ponds over short distances and for lures, which are presented with slowly retrieving. The solid carbon fiber tip is extremely sensitive and detects also softest bites. The power reserves are very limited, especially when fighting against big trouts. Thus the fight can last a bit longer, but is in anyway a special event.

Spinning & Predator Rods

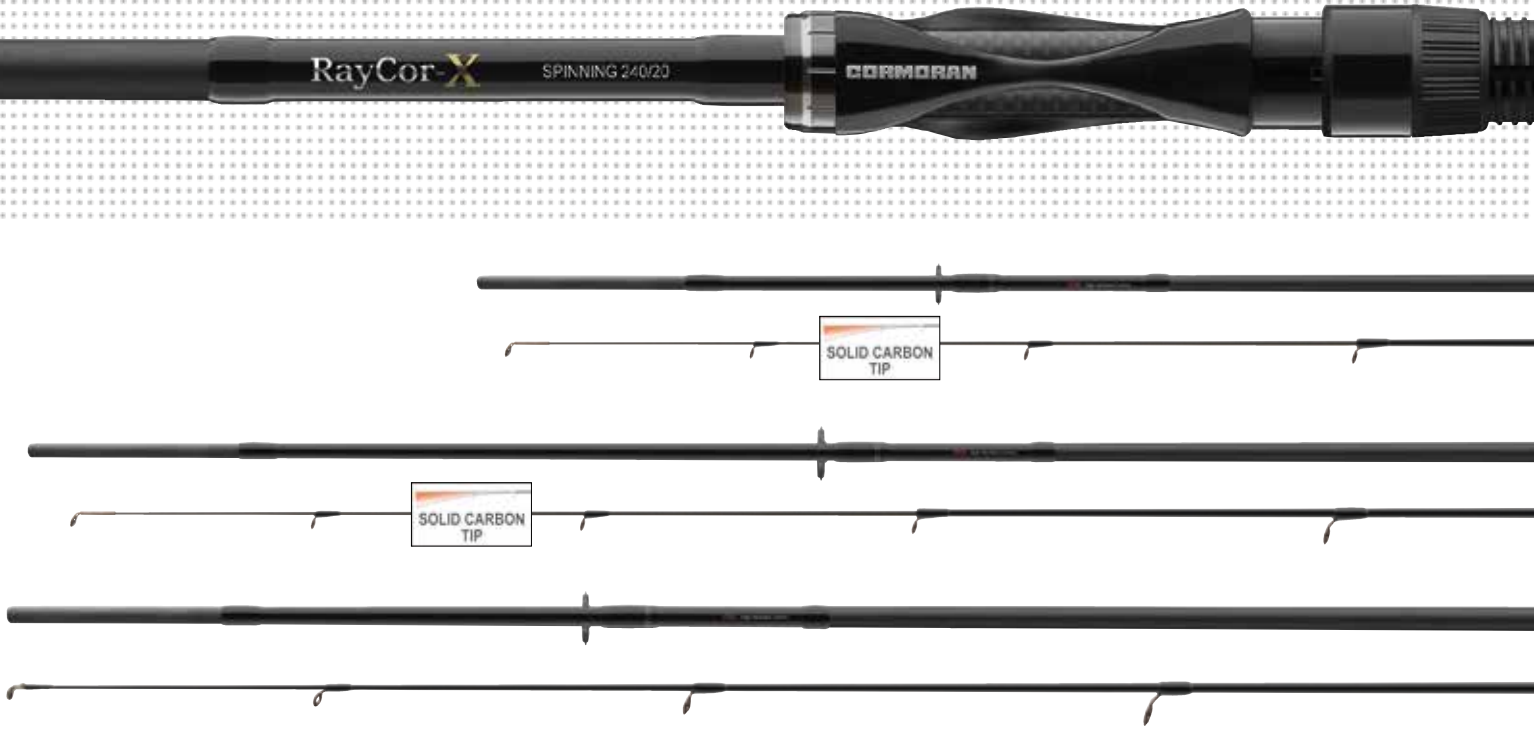

RAYCOR X SPINNING

The evolution continues – the RayCor-X again sets new standards.

The X within the name RayCor stands for “extra-fast”: ultra-fast action for a perfect lure presentation, for long, precise casts and a fast, immediate setting of the hook. Equipped with ergonomically perfectly shaped “High-Touch” reel seat, which enables straight contact to the rod’s vibes and fixes the reel safely. When other anglers reach their personal limits with their rods, the RayCor-X sets new benchmarks. It’s power reserves ensure safety and a plus regarding performance. The RayCor-X easily stands powerful casts – increase your casting distances and set the hook even over great distance. Furthermore, you can exactly feel the movements of your lure at the end of the line in every situation – an advantage, many anglers do not know because they never experienced this sensitivity with their equipment. We offer models for nearly all kind of fishing, no matter if for ultra-light finesse-fishing with mini plugs or heavy fishing with soft plastic lures for big pikes.



- High modulus carbon fiber blank (HMC)
- Premium EVA grip
- Sensi-touch reel seat
- SiC guides
- Hook keeper
- Cloth bag

RAYCOR X SPIN

SPINNING ROD | L-H | TIP-ACTION

Latest spinning rod with a fast tip action for long, precise casts. The RayCor-X Spin is lightweight and well-balanced.

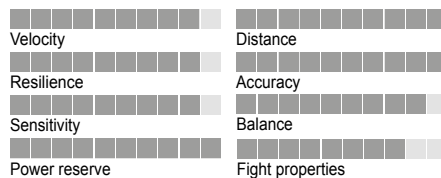

- Specialty**
- Solid carbon fiber tip, highly sensitive
  - Ultra-fast tip action
  - Perfect bite detection



Art.-No.	Length m	CW g	Action	Closed L. cm	Sect.	Guides	Weight g
27-8003022	2.20	10-30	extra fast	114	2	7	115
27-8003524	2.40	10-35	extra fast	125	2	7	125
27-8005022	2.20	10-50	extra fast	114	2	7	120
27-8005024	2.40	10-50	extra fast	125	2	7	130
27-8007024	2.40	30-70	extra fast	125	2	7	150



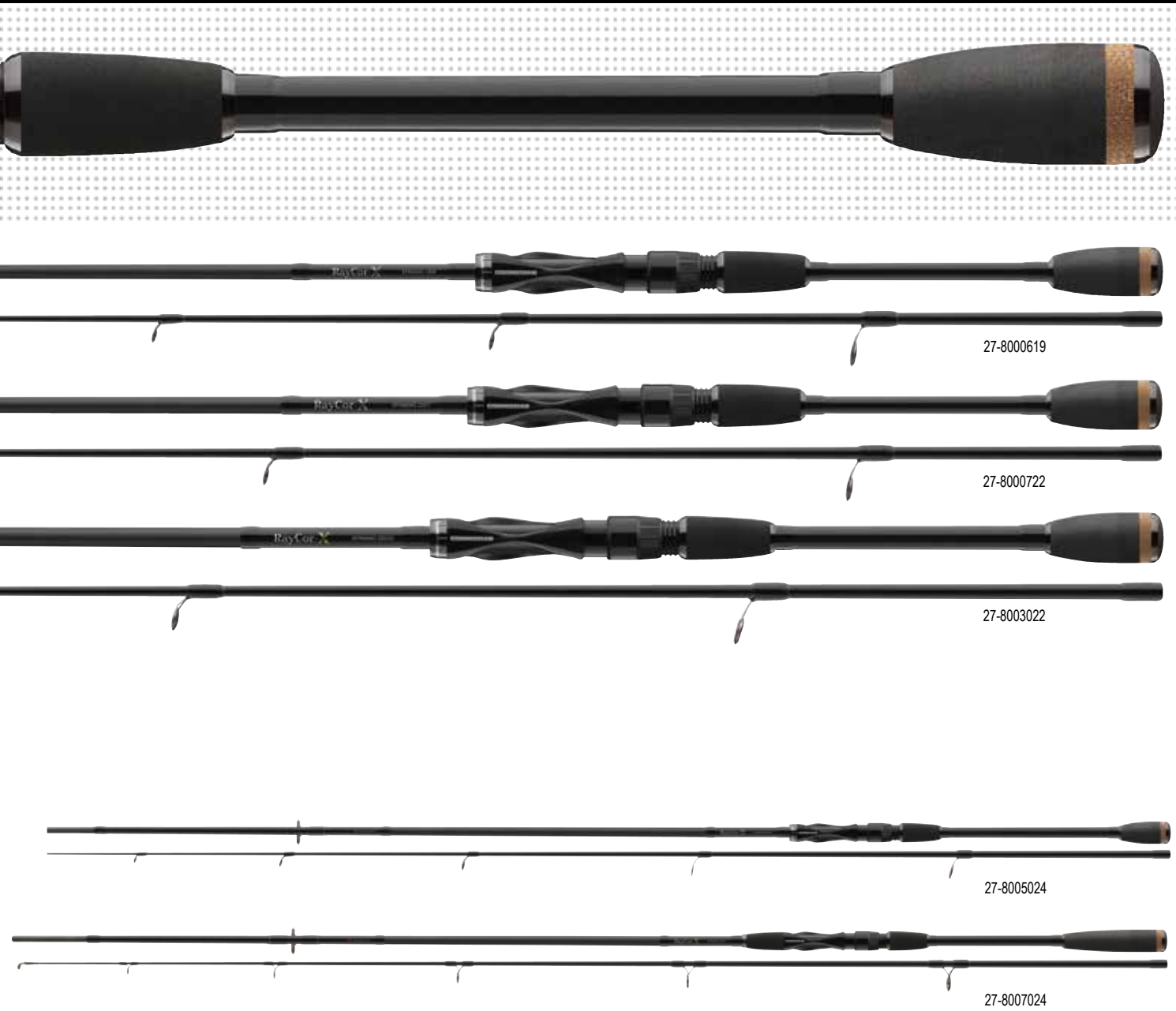

**RAYCOR X UL / LIGHT SPIN**

SPINNING ROD | UL | L | SENSI-TIP

Sensitive spinning rod with spliced-in solid carbon fiber tip for fishing with small and smallest lures for perch, zander, trout, chub etc.

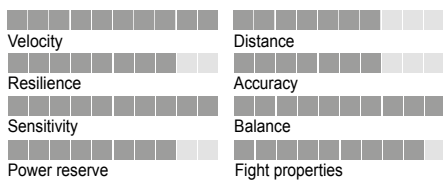

**Specialty**

- Tip action for sensitive bite detection
- High power



Art.-No.	Length m	CW g	Action	Closed L. cm	Sect.	Guides	Weight g
27-8000619	1.95	1-6	extra fast	102	2	8	95
27-8000722	2.20	1-7	extra fast	114	2	8	90
27-8001020	2.05	3-10	extra fast	106	2	8	105
27-8001821	2.10	4-18	extra fast	110	2	8	120

Spinning & Predator Rods



**BLACK MASTER SPINNING**

The inseparable combination of technology and fishing fun.

Developed for nearly all fields of application of modern spin fishing with braided and mono lines, the latest Black Master rods feature a fast action and low weight combined with an outstanding rod balance. The foundation of these special properties is set by the use of our High-Strength SM20 carbon fiber material, which cares for dynamic actions and robust blanks.

The equipment of the Black Master rods comprises a cork handle, lightweight SiC guides, a solid and functional screw-in reel seat as well as a cloth bag, which protects the rod parts also during transportation. The blanks are made of SM20 carbon fiber.

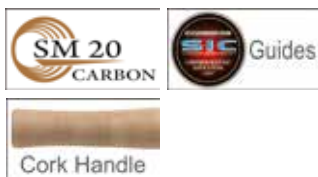

- SM20 carbon fiber blank
- Premium cork grip
- Functional reel seat
- SiC guides
- Hook keeper
- Cloth bag





27-2040240

27-2060240

**BLACK MASTER SPIN**

SPINNING ROD | L | M

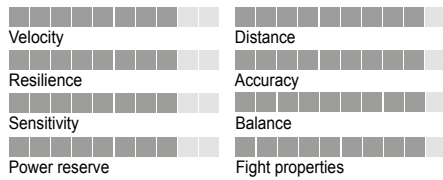

**Specialty**  
• Universal spinning rod



Art.-No.	Length m	CW g	Action	Closed L. cm	Sect.	Guides	Weight g
27-2025180	1.80	5-25	fast	95	2	6	110
27-2025210	2.10	5-25	fast	110	2	7	125
27-2025240	2.40	5-25	fast	125	2	7	150
27-2025270	2.70	5-25	fast	140	2	8	185
27-2040210	2.10	10-40	fast	109	2	7	140
27-2040240	2.40	10-40	fast	125	2	7	165
27-2040270	2.70	10-40	fast	140	2	8	190
27-2040300	3.00	10-40	fast	155	2	9	235

Spinning & Predator Rods

**BLACK MASTER POWER SPIN**

SPINNING ROD | MH | H | XH

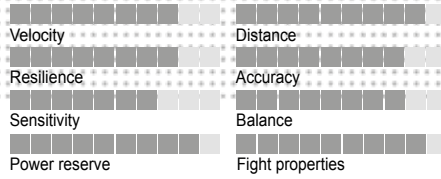

**Specialty**

- Universal spinning rods for heavier weights and strains



Art.-No.	Length m	CW g	Action	Closed L. cm	Sect.	Guides	Weight g
27-2060240	2.40	20-60	progressive	125	2	7	180
27-2060270	2.70	20-60	progressive	140	2	8	190
27-2060300	3.00	20-60	progressive	155	2	9	260
27-2080270	2.70	35-80	progressive	140	2	8	245
27-2080300	3.00	35-80	progressive	155	2	9	280
27-2125270	2.70	40-125	progressive	140	2	8	280

**BLACK MASTER UL SPIN**

FINESSE SPINNING ROD | UL | SENSI-TIP

Especially developed for finesse fishing with mini lures.

The highly sensitive tip is an excellent bite indicator, which reacts even towards the softest taps of perch and trout.

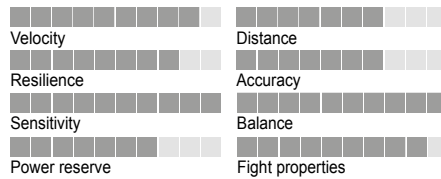

**Specialty**

- Solid carbon fiber tip, highly sensitive
- SiC single leg guides



Art.-No.	Length m	CW g	Action	Closed L. cm	Sect.	Guides	Weight g
27-2014200	2.05	3-14	fast	107	2	7	125

**BLACK MASTER JIGGERSPIN**

JIG SPINNING ROD | ML | M | TIP-ACTION

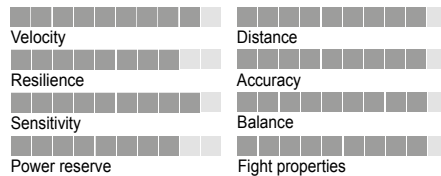

**Specialty**

- Typical jiggerspin tip action, very fast
- Sensi-Touch reel seat
- SiC single leg guides



Art.-No.	Length m	CW g	Action	Closed L. cm	Sect.	Guides	Weight g
27-2028240	2.40	7-28	extra fast / fast	124	2	7	165
27-2028270	2.70	7-28	extra fast / fast	140	2	8	200
27-2035270	2.70	8-35	extra fast / fast	140	2	8	220





27-4007205

## CROSS WATER SPINNING

### CROSS WATER SPOON TROUT

#### TROUT SPINNING ROD | UL-PARABOLIC

Perfect trout spinning rod with parabolic action for fishing with small spoons, spinners and minijigs. The casting weight is optimally designed for small, lightweight trout spoons, which can be cast over long distances.

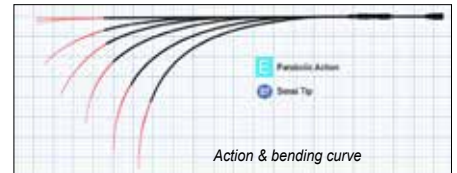
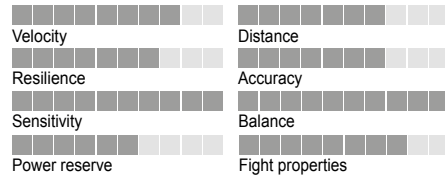

**Specialty**

- Solid carbon fiber tip, highly sensitive and colored
- Very slim blank



Art.-No.	Length m	CW g	Action	Closed L. cm	Sect.	Guides	Weight g
27-4005185	1.85	0.5-5	UL-parabolic	96	2	7	80
27-4007185	1.85	1-7	UL-parabolic	96	2	7	80
27-4007205	2.05	1-7	UL-parabolic	107	2	9	85

## Rod Accessories

### ROD BELT SET

Essential for the safe transport of 2-piece rods. The set contains 2 different sized rod belts, suitable for all rods.

Material: 90% neoprene, 10% nylon



Art.-No.	Content Set pc.
94-19999	2



## PRO CARP XR

Super-affordable carp rods with strong backbone and superb fighting characteristics.

The Pro Carp XR rod series is equipped with a modern, progressive action. The blank is made of SM24 carbon fiber and mediates a perfect sensitivity to the handle section during the fight – thus an extraordinary fighting experience is guaranteed. For reaching long distances, these rods effectively load during the cast. Thanks to the outstanding absorbing qualities, the risk of losses right before the net is reduced significantly. Thus even powerful flights can be absorbed easily and the carp can be directed straight over the net.



- SM24 carbon fiber blank
- EVA grip
- Functional reel seat
- SiC guides
- Cloth bag



### PRO CARP XR | 2-SECT.

CARP ROD | 3.00-3.50LB

Art.-No.	Length m	Length ft	TC lb	Action	Closed L. cm	Sect.	Guides	Weight g
20-0630360	3.60	12.0	3.00	progressive	187	2	6	330
20-0630361	3.60	12.0	3.00	progressive	187	2	6	330
20-0635390	3.90	13.0	3.50	progressive	202	2	6	420

### PRO CARP XR STALKER CARP

STALKER CARP ROD | 3.00LB

Art.-No.	Length m	Length ft	TC lb	Action	Closed L. cm	Sect.	Guides	Weight g
20-0630300	3.00	10.0	3.00	progressive	157	2	6	275



## Coarse Fishing Rods

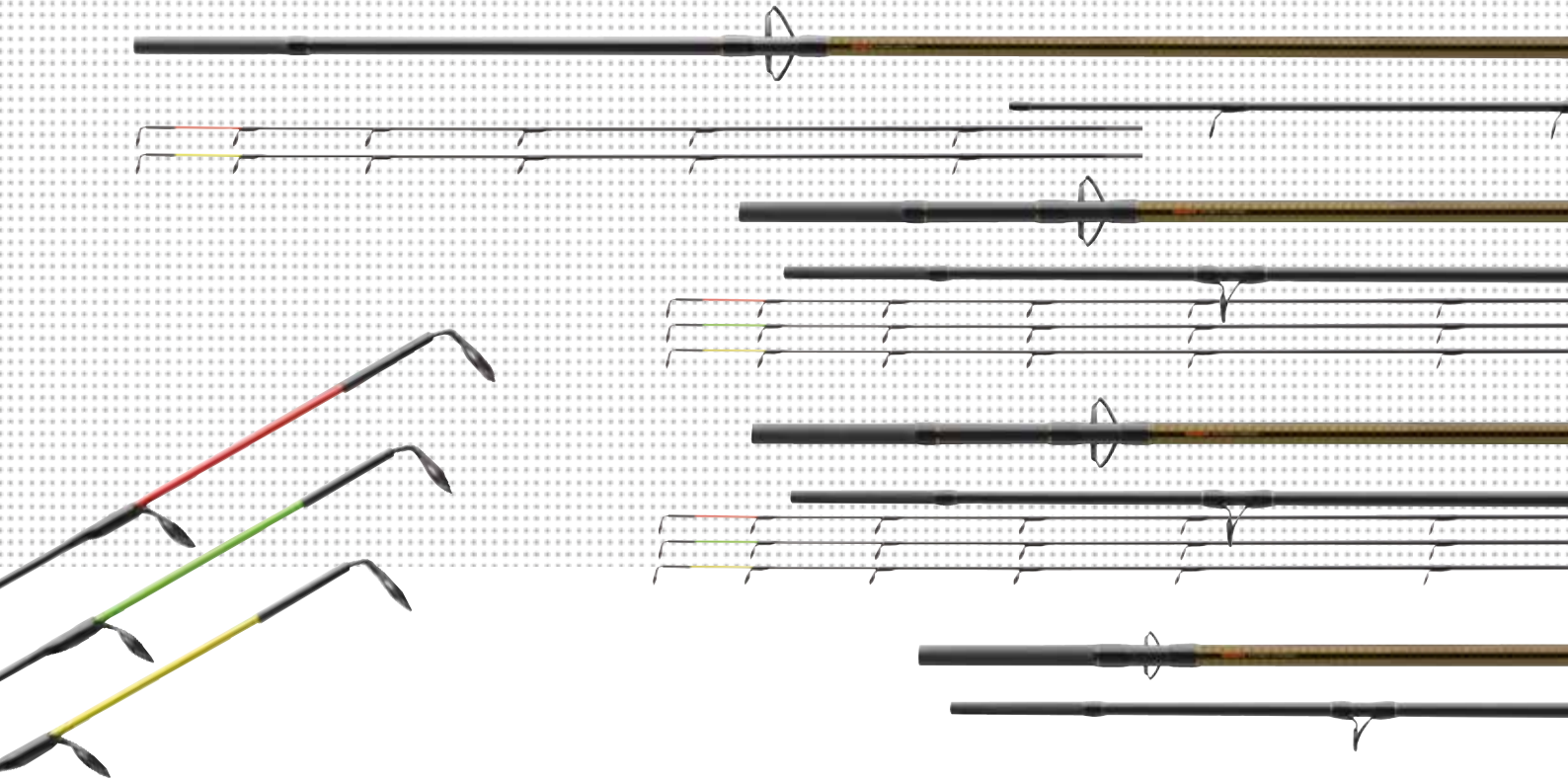

### GF FEEDER PRO

Extraordinary feeder rods.

Wonderfully slim and powerful feeder rods, which are characterized by their light weight and pleasant balance. The blanks of the new GF Feeder Pro rods are made of SM24 carbon fiber material, which provides the rods with great casting dynamics and power transmission for long, targeted casts.

Equipped with light, line-protecting SiC guides and a long cork/EVA handle.  
3 quiver tips (Short Track feeder rods: 2 tips) as well as cloth bag are included.

### GF FEEDER PRO

#### FEEDER ROD | MH-XXH

Art.-No.	Length m	CW g	Action	Closed L. cm	Sect.	Guides	Weight g
25-2120337	3.30	40-120	medium fast	118	3+3	14	250
25-2120367	3.60	40-120	medium fast	128	3+3	14	285
25-2120397	3.90	40-120	medium fast	138	3+3	14	310
25-2150367	3.60	50-150	medium fast	128	3+3	14	285
25-2150397	3.90	50-150	medium fast	138	3+3	14	320
25-2180367	3.60	60-180	medium fast	128	3+3	14	290
25-2180397	3.90	60-180	medium fast	138	3+3	14	320
25-2230367	3.60	80-230	medium fast	128	3+3	14	300
25-2230397	3.90	80-230	medium fast	138	3+3	14	330



- SM24 carbon fiber blank
- High-quality cork / EVA grip
- SiC guides
- Cloth bag

### GF FEEDER PRO SHORT TRACK

#### STALKER FEEDER ROD | XH

Art.-No.	Length m	CW g	Action	Closed L. cm	Sect.	Guides	Weight g
25-2170307	3.00	50-170	medium fast	156	2+2	12	225



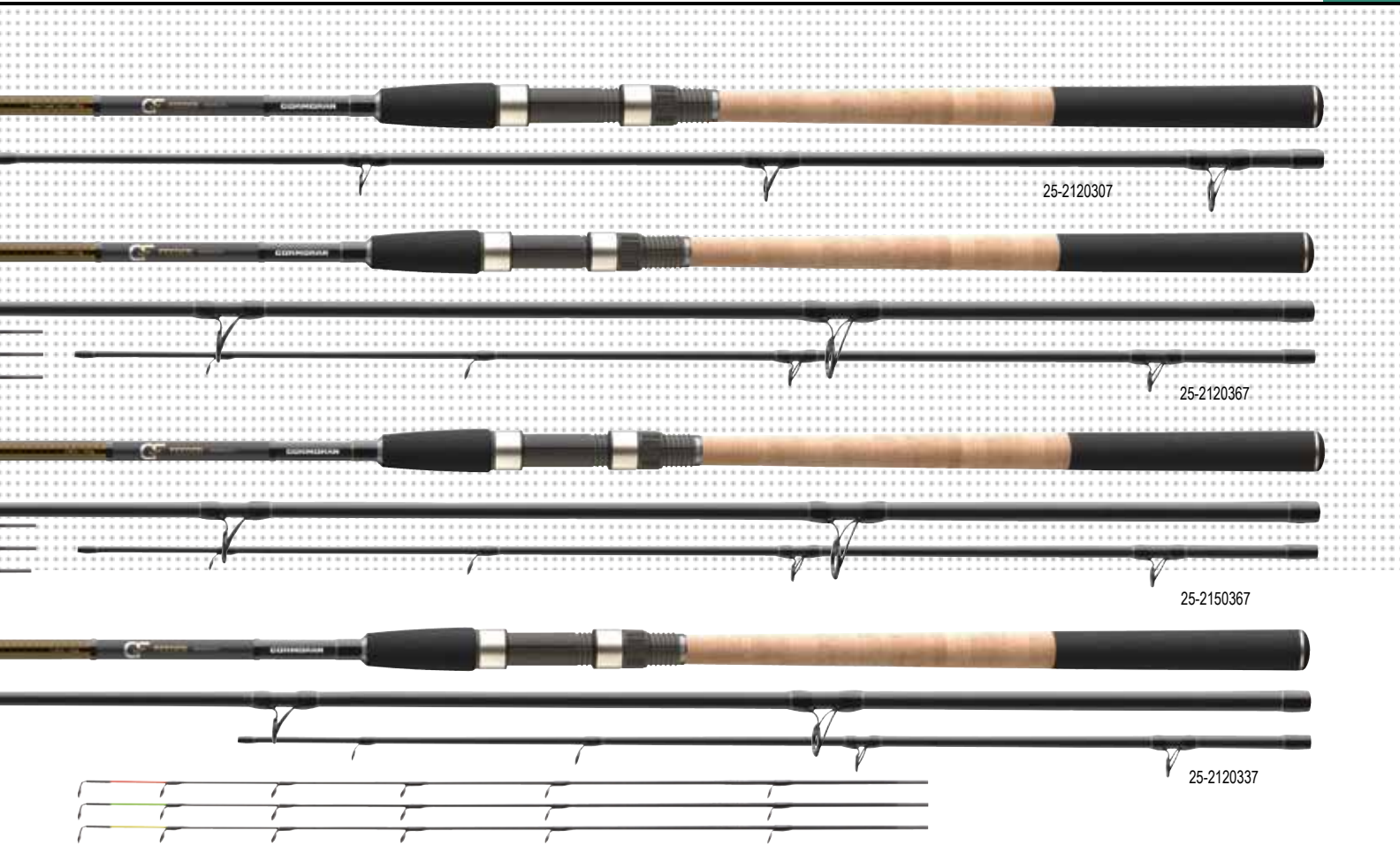

**FEEDERTIPS FOR GF FEEDER PRO**

Art.-No.	Matching with Rod(s) Art.-No.	Matching with Rod(s) CW g	Color	Type	TC oz
25-2120R	25-2120337, 25-2120367, 25-2120397	-120	red	HQ	3.50
25-2120G	25-2120337, 25-2120367, 25-2120397	-120	green	MQ	2.50
25-2120Y	25-2120337, 25-2120367, 25-2120397	-120	yellow	LQ	1.50
25-2150R	25-2150367, 25-2150397	-150	red	HQ	3.50
25-2150G	25-2150367, 25-2150397	-150	green	MQ	2.50
25-2150Y	25-2150367, 25-2150397	-150	yellow	LQ	1.50
25-2180360R	25-2180367	-180	red	HQ	4.00
25-2180360G	25-2180367	-180	green	MQ	3.00
25-2180360Y	25-2180367	-180	yellow	LQ	2.00
25-2180390R	25-2180397	-180	red	HQ	4.00
25-2180390G	25-2180397	-180	green	MQ	3.00
25-2180390Y	25-2180397	-180	yellow	LQ	2.00
25-2230R	25-2230367, 25-2230397	-230	red	HQ	4.00
25-2230G	25-2230367, 25-2230397	-230	green	MQ	3.00
25-2230Y	25-2230367, 25-2230397	-230	yellow	LQ	2.00
25-2170300R	25-2170307	-170	red	HQ	3.50
25-2170300Y	25-2170307	-170	yellow	SQ	2.50

## Coarse Fishing Rods

## BULL FIGHTER

FEEDER 3.60m / 90g

## BULL FIGHTER FEEDER

The new Bull Fighter Feeder and Picker rods are slimmer, more lightweight and feature a stronger backbone than the previous models.

Be delighted by a completely new carbon fiber series, which offers much more than you expect. Beyond the design, which would excel also much pricier rods, also the stiff blank and the equipment convince at first glance.

Titanium-oxid guides, a split EVA handle and a functional Screw-Down reel seat are everything but normal within this price range. Delivered with cloth bag.



- IM6 carbon fiber blank
- Premium EVA grip
- Screw-down reel seat
- Titanium oxide guides
- Cloth bag

## BULL FIGHTER FEEDER

## FEEDER ROD | M-XXH

These rods enable also the occasional fisherman to target the desired spot easily. The powerful IM6 carbon fiber blanks equip the Bull Fighter feeder rods with much power for long and accurate casts.

Thanks to the interchangeable quiver tips perfectly adopted bite detection is guaranteed, since the fish does not feel any resistance like at float or ground fishing.

Equipped with titanium-oxid guides and long split EVA handle, which ensures an optimal lever for long and powerful casts. Delivered with 2 glass fiber quiver tips.

Art.-No.	Length m	CW g	Action	Closed L. cm	Sect.	Guides	Weight g
25-9090367	3.60	30-90	progressive	128	3+2	12	220
25-9120367	3.60	40-120	progressive	128	3+2	12	235
25-9150367	3.60	50-150	progressive	128	3+2	12	260
25-9150397	3.90	50-150	progressive	138	3+2	12	270
25-9180367	3.60	60-180	progressive	128	3+2	12	275
25-9180397	3.90	60-180	progressive	138	3+2	12	300
25-9230367	3.60	80-230	progressive	128	3+2	12	280
25-9230397	3.90	80-230	progressive	138	3+2	12	320

## BULL FIGHTER SHORT TRACK FEEDER

## STALKER FEEDER ROD | MH | XH

The Bull Fighter Short Track feeder rods come into play, when long classic feeder rods are too unhandy, like at stalking feeder fishing. Perfect for frequent spot changes or fishing near the bank.

Equipped with titanium-oxid guides, EVA handle and 2 glass fiber quiver tips.

Art.-No.	Length m	CW g	Action	Closed L. cm	Sect.	Guides	Weight g
25-9120307	3.00	40-120	progressive	152	2+2	10	180
25-9170307	3.00	50-170	progressive	152	2+2	10	200

## BULL FIGHTER PICKER

## PICKER ROD | L

The Bull Fighter Picker rods on the one hand are strong enough for the fishing with small unleaded feeders in silent waters as well as in rivers with little current. On the other hand these rods are designed to detect even softest bites.

Equipped with titanium-oxid guides, slim EVA handle and 2 glass fiber quiver tips.

Art.-No.	Length m	CW g	Action	Closed L. cm	Sect.	Guides	Weight g
25-9030277	2.70	5-30	balanced	138	2+2	9	125

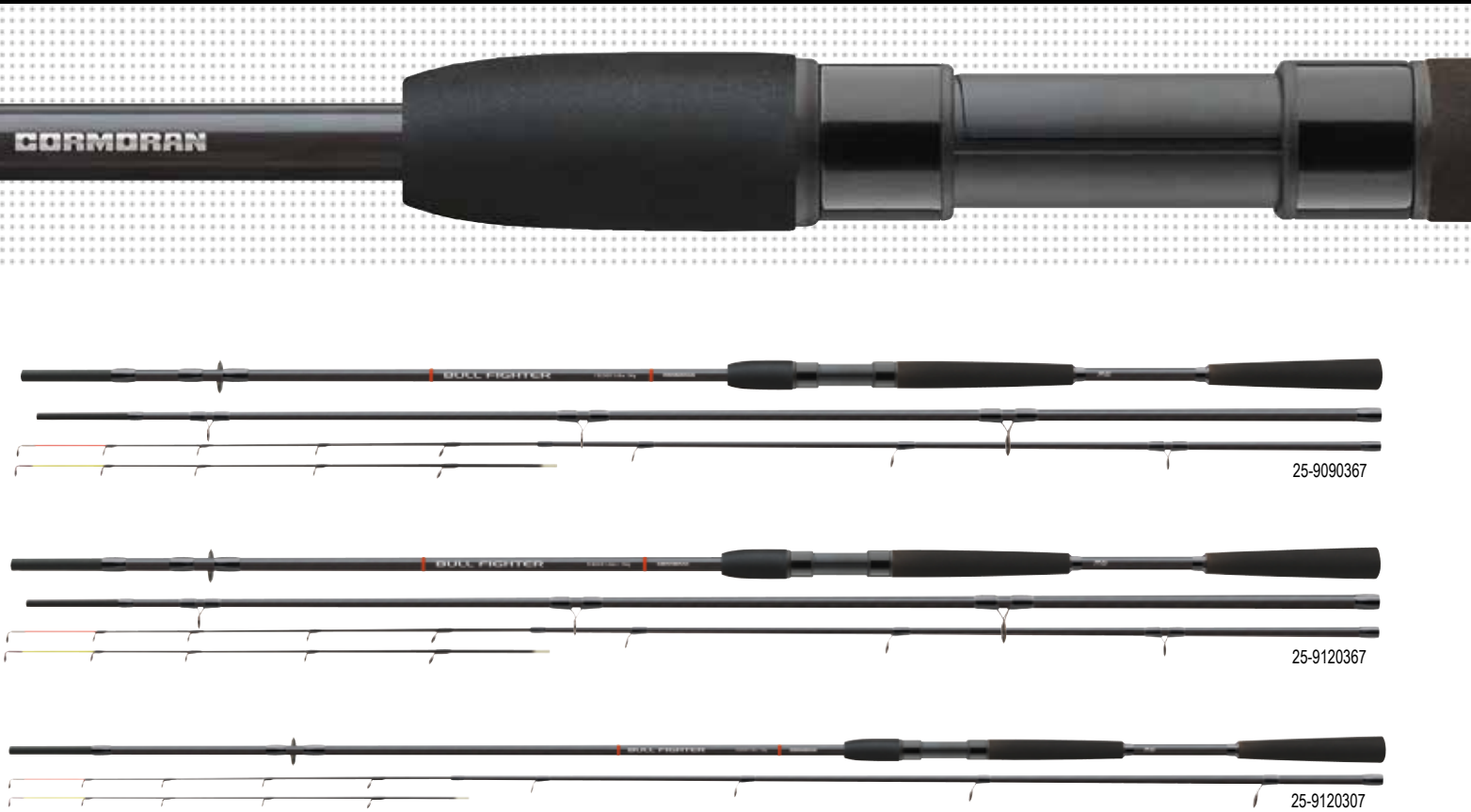

**FEEDERTIPS FOR BULL FIGHTER FEEDER**

Art.-No.	Matching with Rod(s) Art.-No.	Matching with Rod(s) CW g	Color	Type
25-10090R	25-9090367, 25-9120367, 25-9150367, 25-9150397	-90/-150	red	MQ
25-10090Y	25-9090367, 25-9120367, 25-9150367, 25-9150397	-90/-150	yellow	LQ
25-10180R	25-9180367, 25-9180397, 25-9230367, 25-9230397, 25-9170307	-170/-180/-230	red	HQ
25-10180Y	25-9180367, 25-9180397, 25-9230367, 25-9230397, 25-9170307	-170/-180/-230	yellow	MQ
25-10120R	25-9120307	-120	red	HQ
25-10120Y	25-9120307	-120	yellow	LQ

**QUIVERTIPS FOR BULL FIGHTER PICKER**

Art.-No.	Matching with Rod(s) Art.-No.	Matching with Rod(s) CW g	Color	Type
25-10030R	25-9030277	-30	red	HQ
25-10030Y	25-9030277	-30	yellow	LQ

Coarse Fishing Rods



24-0120365

24-0150365

24-0120305

**SPORTLINE FEEDER**

„High Density Composite“ carbon fiber technology even for our economic rods.

Very robust and highly strainable feeder and coarse fishing rods, which offer much fun also at the fight with smaller fish thanks to the special fiber design.

Equipped with titanium oxide guides and EVA handles.



**SPORTLINE FEEDER**

FEEDER ROD | M | MH | H

Powerful feeder rods with dynamic longcast action and strong backbone for casting also heavy feeder rigs to long distances without problems.

Delivered with 3 quiver tips:

- red = H-stiff yellow = M-medium green = L-light

- HDG composite blank
- EVA grip
- Titanium oxide guides
- Cloth bag

Art.-No.	Length m	CW g	Action	Closed L. cm	Sect.	Guides	Weight g
24-0100335	3.30	30-100	semi-parabolic	116	3+3	12	280
24-0100365	3.60	30-100	semi-parabolic	127	3+3	12	370
24-0120335	3.30	40-120	semi-parabolic	116	3+3	12	290
24-0120365	3.60	40-120	semi-parabolic	127	3+3	12	385
24-0150335	3.30	50-150	semi-parabolic	116	3+3	12	310
24-0150365	3.60	50-150	semi-parabolic	127	3+3	12	400
24-0150395	3.90	50-150	semi-parabolic	137	3+3	12	450



**SPORTLINE SHORT TRACK FEEDER**

**STALKER FEEDER ROD | MH**

The Short Track is applied, when classical long feeder rods are too unhandy or when you are fishing near the bank.

Delivered with 3 feeder tips:

- red = H-stiff yellow = M-medium green = L-light

Art.-No.	Length m	CW g	Action	Closed L. cm	Sect.	Guides	Weight g
24-0120305	3.00	40-120	semi-parabolic	107	3+3	10	230

**FEEDERTIPS FOR SPORTLINE FEEDER**

Art.-No.	Matching with Rod(s) Art.-No.	Matching with Rod(s) CW g	Color	Type
24-9105R	24-0120305, 24-0100335, 24-0100365, 24-0120335, 24-0120365, 24-0150335, 24-0150365, 24-0150395	-100/-120/-150	red	HQ
24-9105Y	24-0120305, 24-0100335, 24-0100365, 24-0120335, 24-0120365, 24-0150335, 24-0150365, 24-0150395	-100/-120/-150	yellow	MQ
24-9105G	24-0120305, 24-0100335, 24-0100365, 24-0120335, 24-0120365, 24-0150335, 24-0150365, 24-0150395	-100/-120/-150	green	LQ

Coarse Fishing Rods

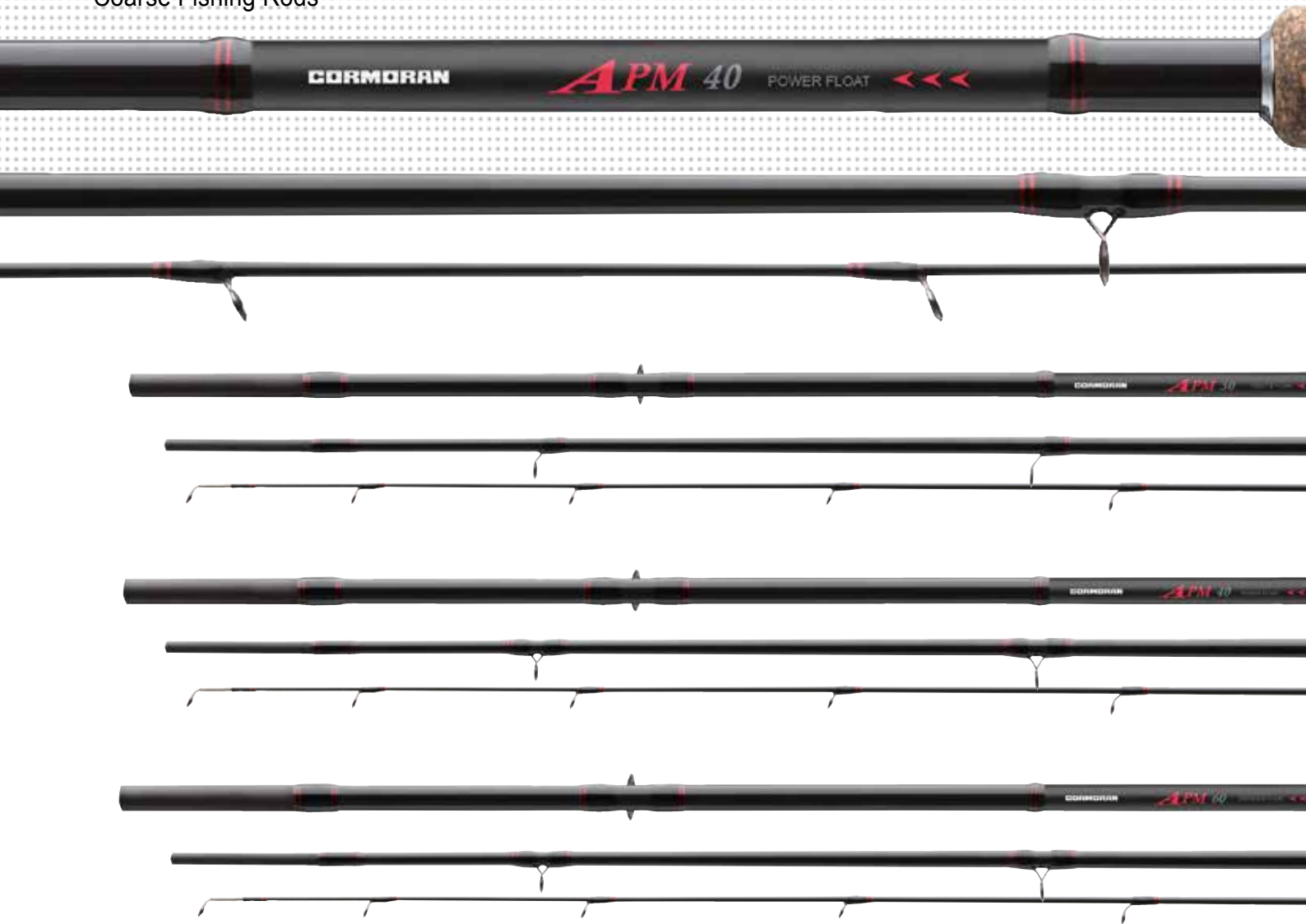

**APM FLOAT**

High-end float rods.

Not only feeder fishing is gaining popularity, but also float fishing gets more and more sophisticated and is in continuous progression. Improved fishing techniques and an elaborate supply range demand rods, which are able to realize this potential. Longer casts, more sensitive fishing and a more controlled fight with the fish are the demands. With the CORMORAN APM rods we developed three series, which cover all areas of float fishing like coarse, zander, and fishing for trout at ponds.

Made of SM24 carbon fiber, refined with SiC guides and a superior cork handle.

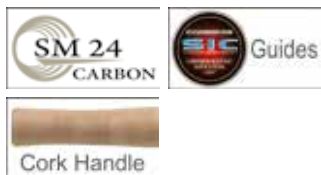

**APM 30 TROUT & FLOAT**

FLOAT ROD | CW -30G

The APM 30 Trout & Float features a lightweight and slim blank with distinct tip action. Thanks to the sensitive action these rods are perfectly applicable for fishing with sbirolinos as well as for coarse fishing and fishing for zander with small baitfish.

- SM24 carbon fiber blank
- Premium cork grip
- Screw-down reel seat
- SiC guides
- Cloth bag

Art.-No.	Length m	CW g	Action	Closed L. cm	Sect.	Guides	Weight g
25-4030361	3.60	10-30	medium fast	125	3	13	240
25-4030391	3.90	10-30	medium fast	138	3	14	260



25-4030361

25-4040361

25-4060361

**APM 40 POWER FLOAT**

FLOAT ROD | CW -40G

Powerful float rod for casting weights of 10-40g with fast tip and a strong backbone for fishing with wagglers and pole floats. For coarse fishing as well as for zander fishing or trout fishing over great distances at big ponds.

Art.-No.	Length m	CW g	Action	Closed L. cm	Sect.	Guides	Weight g
25-4040361	3.60	10-40	medium fast	125	3	13	265
25-4040391	3.90	10-40	medium fast	138	3	14	285

**APM 60 DISTANCE FLOAT**

FLOAT ROD | CW -60G

Universal powerful float rod for casting rigs up to 60g with fast tip and strong backbone for targeting large coarse fish and carps. The APM Distance Float 60 keeps the promises of its name: designed for long casts to act with float rigs on far remote spots. Even for fishing with large sbirolinos for large trouts and ponds this rod is the proper choice.

Art.-No.	Length m	CW g	Action	Closed L. cm	Sect.	Guides	Weight g
25-4060361	3.60	15-60	medium fast	125	3	13	270



## SPECILAND ULTRA FEEDER



### FEEDER ROD | XXH

Ultra-power feeder with up to 300g casting weight.

The perfect feeder rod for large streams like the river Rhine. The Speciland Ultra Feeder features a strong backbone and great power for the cast and fight.

The sensitivity can be adjusted variably thanks to the 3 carbon fiber quiver tips with 3oz, 4oz and 5oz.

- SM20C carbon fiber blank
- High-quality cork / EVA grip
- SiC guides
- Cloth bag

Art.-No.	Length m	CW g	Action	Closed L. cm	Sect.	Guides	Weight g
25-5300399	3.90	-300	medium fast	142	3+3	14	390
25-5300429	4.20	-300	medium fast	151	3+3	14	430



25-5300399

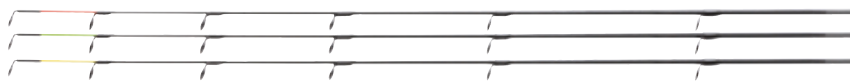

### FEEDERTIPS FOR SPECILAND ULTRA FEEDER

Art.-No.	Matching with Rod(s) Art.-No.	Matching with Rod(s) CW g	Color	Type
25-5300R	25-5300399, 25-5300429	-300	red	super stiff
25-5300G	25-5300399, 25-5300429	-300	green	extra stiff
25-5300Y	25-5300399, 25-5300429	-300	yellow	stiff





24-25369

## DISTANCE MATCH

MATCH ROD | CW -25G

Modern technology, modern design.

The newly revised Distance Match carbon fiber rod series is characterized by an excellent price-performance ratio. With its fast action and powerful backbone, it can also cast bigger wagglers over great distances very precisely. Also perfectly suited for trout fishing at the pond.



- SM24 carbon fiber blank
- High-quality cork / EVA grip
- SIC guides
- Cloth bag

Art.-No.	Length m	CW g	Action	Closed L. cm	Sect.	Guides	Weight g
24-25369	3.60	5-25	medium fast	127	3	13	190
24-25399	3.90	5-25	medium fast	137	3	14	205
24-25429	4.20	5-25	medium fast	147	3	15	230
24-25459	4.50	5-25	medium fast	158	3	16	255



26-2050241

## PROFILINE TELE TRAVEL

TRAVEL ROD

Short-sectioned spinning- and all-round rods, which are characterized by their good transportability as well as by their fast tip action and a good balance.

Art.-No.	Length m	CW g	Action	Closed L. cm	Sect.	Guides	Weight g
26-2025181	1.80	5-25	progressive	46	5	4	130
26-2040211	2.10	10-40	progressive	55	5	4	155
26-2050241	2.40	15-50	progressive	60	6	5	230
26-2060271	2.70	20-60	progressive	62	6	5	235
26-2070301	3.00	30-70	progressive	65	7	6	320



26-000401

## EUROCOR TELE POLE

POLE ROD

This pole series is very economic priced and good for catching bait fish and for any occasional anglers.

Art.-No.	Length m	Action	Closed L. cm	Sect.	Weight g
26-000301	3.00	balanced	114	3	150
26-000401	4.00	balanced	114	4	250
26-000501	5.00	balanced	114	5	360
26-000601	6.00	balanced	114	6	500
26-000701	7.00	balanced	114	7	790

Catfish Rods

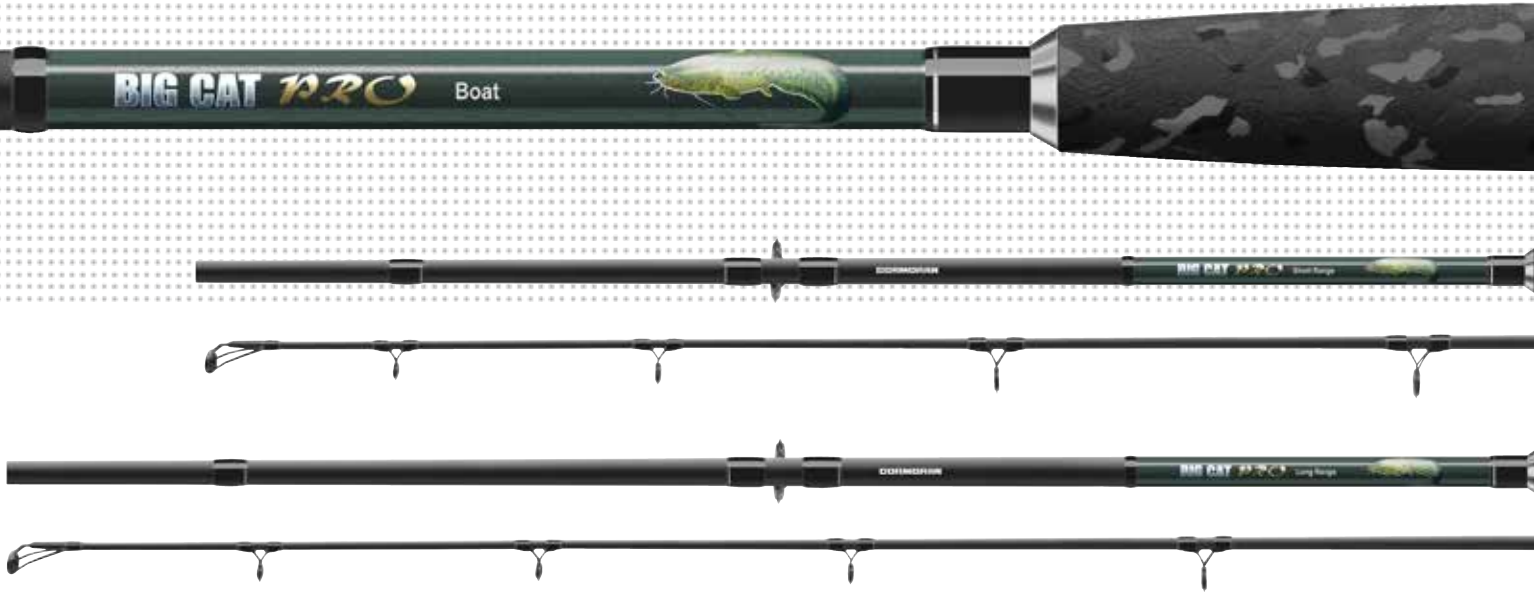

# BIG CAT



## BIG CAT PRO

Tough, indestructible and featuring a perfect bending curve.

Made of high-density carbon fiber composite. This is the material from we produce the high-density blanks of our catfish rods, which are capable of standing up against every large catfish during the fight thanks to their fast reaction, regardless if you have to react to whiplike shocks from the tail or fierce flights. The pressure you can exert on large catfish with these rods is huge.



- High-density composite carbon fiber blank
- Reliable spigot joint
- EVA grip (camouflage design)
- Heavy-duty reel seat
- SiC guides

### BIG CAT PRO SHORT & LONG RANGE

CATFISH ROD | XXH | XXXH

Art.-No.	Length m	CW g	Action	Closed L. cm	Sect.	Guides	Weight g
20-1400285	2.80	100-400	progressive	146	2	8	425
20-1600305	3.00	200-600	progressive	156	2	9	495
20-1600335	3.30	200-600	progressive	172	2	10	615



20-1400285



20-1600305



29-1600230

**SEACOR HALIBUT HDC INTERLINE**

INLINE BOAT ROD | XXH | XXXH

If something big is lying in wait for your lure in the depth of Norway's fjords, you are perfectly armed with a Halibut HDC Interline rod.

The Halibut HDC Interline rods are uncompromisingly strong and resist powerfully, when a big sea predator tries to escape. They are made for fighting by hook or crook.

Thanks to the long tip, which is directly mounted at the handle section, the center of strain is located very low, which allows transmitting of the whole force to the rod. Despite their pure power, these rods are extraordinary sensitive, feature a very delicate bite detection and therefore cover nearly the whole range of heavy fishing in the Norwegian fjords, regardless if you target halibut, ling, cod or wolffish.

Equipped with premium screw-winch reel seat and gimbal buttcap.



- HDG composite blank
- Reliable spigot joint
- Solid EVA grip
- Heavy-duty reel seat
- Gimbal butt cap
- Cloth bag



Art.-No.	Length m	CW g	Action	Closed L. cm	Sect.	Weight g
29-1600210	2.10	200-600	medium fast	146	2	440
29-1600230	2.35	200-600	medium fast	164	2	455
29-1100210	2.10	300-1000	medium fast	146	2	505
29-1100230	2.35	300-1000	medium fast	164	2	455

## CORASTRONG 8-BRAID

BRAIDED LINE | GREEN

### The CoraStrong 8-Braid – made of Micro Coramid

No matter where you are fishing, which kind of fish you are targeting or which fishing technique you prefer – with the CoraStrong 8-Braid on your spool you are always on the safe side and can enjoy a line with optimal casting properties due to its tight, smooth braid structure and the exact calibration over the whole length. The CoraStrong 8-Braid is a real high-tech line with an incredible price-performance ratio.

#### Advantage 1: Optimum casting properties due to ...

- the smooth, optimal braid structure – the 8-Braid glides evenly through the guides
- the special coating – reduces friction
- the thin line diameter – less vulnerable at crosswind
- a tight braid structure – no carving in
- absorbs no water – structure remains
- exact calibration over the whole length
- reduced memory-effect – no coiling

#### Advantage 2: Optimal bite detection due to ...

- the slim line diameter – perfect at currents
- little stretch – also softest taps are transmitted

#### Advantage 3: Improved safety during cast and fight due to ...

- the enormous strength – more than enough
- the optimal ratio of diameter and linear strength
- the excellent knot strength
- little stretch – thus faster and more precise hooking
- the high abrasion resistance – ideal for demanding conditions
- UV resistance – resists also intense sun exposure
- the long lifespan – leads to safety



Art.-No.	Color	Capacity m	Ø mm	Strength kg	Strength lb
32-8013510	green	135	0.10	6.30	14.0
32-8013512	green	135	0.12	7.70	17.0
32-8013514	green	135	0.14	9.40	20.5
32-8013516	green	135	0.16	11.40	25.0
32-8013518	green	135	0.18	13.20	29.0
32-8013520	green	135	0.20	15.10	33.0
32-8013525	green	135	0.25	18.80	43.0
32-8013530	green	135	0.30	28.80	62.5
32-8013535	green	135	0.35	37.50	82.5
32-8013540	green	135	0.40	45.20	99.5



Art.-No.	Color	Capacity m	Ø mm	Strength kg	Strength lb
32-8030010	green	300	0.10	6.30	14.0
32-8030012	green	300	0.12	7.70	17.0
32-8030014	green	300	0.14	9.40	20.5
32-8030016	green	300	0.16	11.40	25.0
32-8030018	green	300	0.18	13.20	29.0
32-8030020	green	300	0.20	15.10	33.0
32-8030025	green	300	0.25	18.80	43.0
32-8030030	green	300	0.30	28.80	62.5
32-8030035	green	300	0.35	37.50	82.5
32-8030040	green	300	0.40	45.20	99.5



Art.-No.	Color	Capacity m	Ø mm	Strength kg	Strength lb
32-8120012	green	1200	0.12	7.70	17.0
32-8120014	green	1200	0.14	9.40	20.5
32-8120016	green	1200	0.16	11.40	25.0
32-8120018	green	1200	0.18	13.20	29.0
32-8120020	green	1200	0.20	15.10	33.0
32-8120025	green	1200	0.25	18.80	43.0
32-8120030	green	1200	0.30	28.80	62.5
32-8120035	green	1200	0.35	37.50	82.5
32-8120040	green	1200	0.40	45.20	99.5

## CORASTRONG BRAID

BRAIDED LINE | GREEN

### 25 years CoraStrong – braided of Coramid

With the anniversary CoraStrong CORMORAN has improved a legend among all fishing lines regarding many features. Like this, a real high-performance line has been designed which is excelled by its fantastic price-performance ratio as well as its technical features.



Art.-No.	Color	Capacity m	Ø mm	Strength kg	Strength lb
32-0013512	green	135	0.12	6.40	14.0
32-0013514	green	135	0.14	7.40	16.2
32-0013516	green	135	0.16	8.50	18.7
32-0013518	green	135	0.18	9.80	21.5
32-0013520	green	135	0.20	11.20	24.6
32-0013523	green	135	0.23	13.50	29.7
32-0013525	green	135	0.25	14.30	31.4
32-0013528	green	135	0.28	18.20	40.0
32-0013530	green	135	0.30	21.00	46.1

**Markedly improved casting characteristics thanks to ...**

- smooth, optimal braid structure – glides easily through the guides
- tight braid – no cutting in
- most minimal water absorbance – the structure remains unchanged
- even winding thanks to exact calibration over the whole length
- reduced memory effect – no curls after rewinding the line to the spool

**Markedly improved security at the cast and the fight thanks to ...**

- high linear strength – optimum relation of diameter to breaking strength
- Outstanding knot strength
- negligible stretch for a fast and precise setting of the hook
- extreme abrasion resistance – perfect for waters with underwater barriers
- UV-proof – even intense sun exposition is no problem
- long durability – no need to check the line all the time

Art.-No.	Color	Capacity m	Ø mm	Strength kg	Strength lb
32-0030012	green	300	0.12	6.40	14.0
32-0030014	green	300	0.14	7.40	16.2
32-0030016	green	300	0.16	8.50	18.7
32-0030018	green	300	0.18	9.80	21.5
32-0030020	green	300	0.20	11.20	24.6
32-0030023	green	300	0.23	13.50	29.7
32-0030025	green	300	0.25	14.30	31.4
32-0030028	green	300	0.28	18.20	40.0
32-0030030	green	300	0.30	21.00	46.1
32-0030035	green	300	0.35	26.50	58.2
32-0030040	green	300	0.40	32.00	70.3



Art.-No.	Color	Capacity m	Ø mm	Strength kg	Strength lb
32-0120012	green	1200	0.12	6.40	14.0
32-0120014	green	1200	0.14	7.40	16.2
32-0120016	green	1200	0.16	8.50	18.7
32-0120018	green	1200	0.18	9.80	21.5
32-0120020	green	1200	0.20	11.20	24.6
32-0120023	green	1200	0.23	13.50	29.7
32-0120025	green	1200	0.25	14.30	31.4
32-0120028	green	1200	0.28	18.20	40.0
32-0120030	green	1200	0.30	21.00	46.1
32-0120035	green	1200	0.35	26.50	58.2
32-0120040	green	1200	0.40	32.00	70.3



## PROFILINE TARGET FISH LINE

Well directed fishing with Profiline.  
For every desired fish there is a special Profiline.



### PROFILINE CATFISH

MONOFILAMENT | BLACK



Art.-No.	Color	Capacity m	Ø mm	Strength kg	Strength lb
36-141550	black	200	0.50	17.50	39.3

### PROFILINE ZANDER

MONOFILAMENT | LIGHT BROWN



Art.-No.	Color	Capacity m	Ø mm	Strength kg	Strength lb
36-141122	light brown	450	0.22	4.40	9.9
36-141125	light brown	450	0.25	5.60	12.6
36-141128	light brown	450	0.28	6.60	14.9

### PROFILINE EEL

MONOFILAMENT | BROWN



Art.-No.	Color	Capacity m	Ø mm	Strength kg	Strength lb
36-141440	brown	300	0.40	12.90	29.0
36-141430	brown	400	0.30	7.60	17.0
36-141435	brown	400	0.35	9.90	22.3



The Profiline spools are featured with an integrated „Euro-Hole“ and the line is protected via a transparent protection foil.

### PROFILINE CARP

MONOFILAMENT | DARK BROWN



Art.-No.	Color	Capacity m	Ø mm	Strength kg	Strength lb
36-141230	dark brown	400	0.30	7.60	17.0
36-141235	dark brown	400	0.35	10.00	22.5
36-141225	dark brown	450	0.25	5.70	12.8
36-141228	dark brown	450	0.28	6.60	14.9

### PROFILINE PIKE

MONOFILAMENT | DARK GREEN



Art.-No.	Color	Capacity m	Ø mm	Strength kg	Strength lb
36-141340	dark green	300	0.40	12.90	29.0
36-141330	dark green	400	0.30	7.60	17.0
36-141335	dark green	400	0.35	9.90	22.3

### PROFILINE TROUT

MONOFILAMENT | LIGHT GREY



Art.-No.	Color	Capacity m	Ø mm	Strength kg	Strength lb
36-141618	light grey	450	0.18	3.10	7.0
36-141620	light grey	450	0.20	3.70	8.3
36-141622	light grey	450	0.22	4.40	9.9
36-141625	light grey	450	0.25	5.60	12.6

## LURES

### CORA Z

#### SPOON

The CORMORAN classic spoon is back with classical lengths and weights. Equipped with swivel and a strong, bronzed treble.



- Hook: CGS treble hook
- Equipped with swivel

Art.-No.	Color	Length cm	Weight g	Content pc.
50-860106	silver/silver	3.5	6.0	1
50-860116	silver/silver	5.0	16.0	1
50-860122	silver/silver	5.8	22.0	1
50-860130	silver/silver	6.7	30.0	1
50-860145	silver/silver	8.0	45.0	1

Art.-No.	Color	Length cm	Weight g	Content pc.
50-860206	silver/gold	3.5	6.0	1
50-860216	silver/gold	5.0	16.0	1
50-860222	silver/gold	5.8	22.0	1
50-860230	silver/gold	6.7	30.0	1
50-860245	silver/gold	8.0	45.0	1

Art.-No.	Color	Length cm	Weight g	Content pc.
50-860306	silver/chartreuse	3.5	6.0	1
50-860316	silver/chartreuse	5.0	16.0	1
50-860322	silver/chartreuse	5.8	22.0	1
50-860330	silver/chartreuse	6.7	30.0	1
50-860345	silver/chartreuse	8.0	45.0	1

Art.-No.	Color	Length cm	Weight g	Content pc.
50-860406	gold/gold	3.5	6.0	1
50-860416	gold/gold	5.0	16.0	1
50-860422	gold/gold	5.8	22.0	1
50-860430	gold/gold	6.7	30.0	1
50-860445	gold/gold	8.0	45.0	1

Art.-No.	Color	Length cm	Weight g	Content pc.
50-861006	silver/red scales	3.5	6.0	1
50-861016	silver/red scales	5.0	16.0	1
50-861022	silver/red scales	5.8	22.0	1
50-861030	silver/red scales	6.7	30.0	1
50-861045	silver/red scales	8.0	45.0	1



## SPECIAL PLUGS FOR LIGHT AND ULTRA-LIGHT FISHING.



baby brown trout



carp



metallic brown



watermelon seed



### COR F1 | 35MM

MINI PLUG | FLOATING | UP TO 0.8M DIVING DEPTH

This small plug has especially been developed for ultra-light fishing for trout in streams and ponds as well as for perch and chub. The COR F1 can be presented both slowly and fast.

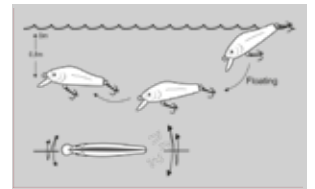

Art.-No.	Color	Length cm	Weight g	Content pc.
53-04351	baby brown trout	3.5	2.0	1
53-04352	carp	3.5	2.0	1
53-04353	metallic brown	3.5	2.0	1
53-04354	watermelon seed	3.5	2.0	1



carp



perch



firetiger



hot orange



### COR F2 | 35MM

MINI PLUG | SLOW SINKING | UP TO 1.2M DIVING DEPTH

This small plug has especially been developed for ultra-light fishing at medium diving depth and catches trout, perch and chub. Very active action.

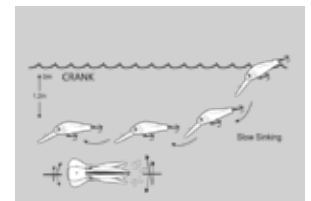

Art.-No.	Color	Length cm	Weight g	Content pc.
53-04361	carp	3.5	2.5	1
53-04362	perch	3.5	2.5	1
53-04363	firetiger	3.5	2.5	1
53-04364	hot orange	3.5	2.5	1



**LURES**



**COR F6 | 70MM**

LONG DISTANCE PLUG | FLOATING | UP TO 0.8M DIVING DEPTH

Universal longcasting plug for all predators, which cuts a fine figure at the lake as well as at currents. The COR F6 can be presented with all modern styles and is even successful at slow, steady retrieving.

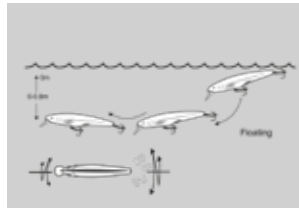

Art.-No.	Color	Length cm	Weight g	Content pc.
53-04701	baby brown trout	7.0	4.0	1
53-04702	dying roach	7.0	4.0	1
53-04703	perch	7.0	4.0	1
53-04704	striped seed	7.0	4.0	1



baby brown trout



dying roach

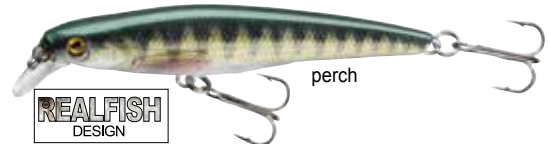

perch



striped seed



**COR F7 | 70MM**

PLUG | FLOATING | UP TO 1.5M DIVING DEPTH

Extremely successful plug for big perch and trout. The COR F7's flanking movements come into action during Stop & Go techniques as well as at twitching. Suited for silent waters and currents. Also ideal for fishing for pike and zander.

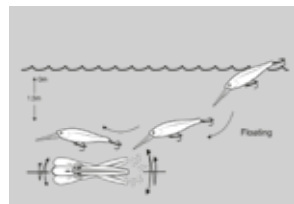

Art.-No.	Color	Length cm	Weight g	Content pc.
53-04711	dying roach	7.0	8.0	1
53-04712	perch	7.0	8.0	1
53-04713	matt ayu	7.0	8.0	1
53-04714	herring	7.0	8.0	1



dying roach



perch



matt ayu



herring

## LURES

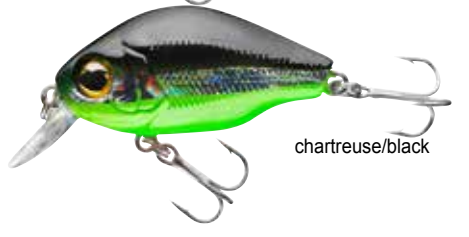

**COR F14 | 45MM**

MINI CRANKBAIT | FLOATING | UP TO 1.2M DIVING DEPTH

This small, relatively heavy Belly Dog Crank can't be overseen by a predator, especially because it produces enormous turbulences. Thanks to its well dosed buoyancy, it slowly rises to the surface during retrieving stops. The compact, spherical shape of the COR F14 enables extremely long and precise casts.

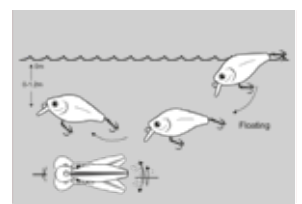

Art.-No.	Color	Length cm	Weight g	Content pc.
53-04421	chocolate	4.5	7.1	1
53-04422	yellow pellet	4.5	7.1	1
53-04423	hot pink	4.5	7.1	1
53-04424	chartreuse/black	4.5	7.1	1



**COR F15 | 37MM**

MINI CRANKBAIT | FLOATING | UP TO 1.6M DIVING DEPTH

Small, compact deep-diving crank which can dupe even one or another zander next to trouts and perchers. The COR F15 is gaining depth really fast and is rising slowly and seductively to the surface during retrieving stops. Equipped with 2 single hooks for optimal sparing of the fish. This crank shouldn't be missing in any lure box.

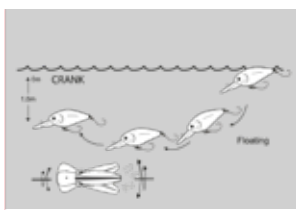

Art.-No.	Color	Length cm	Weight g	Content pc.
53-04431	green pellet	3.7	4.5	1
53-04432	yellow/black	3.7	4.5	1
53-04433	chartreuse/black	3.7	4.5	1
53-04434	brown minnow	3.7	4.5	1

**LURES**



**COR F16 | 27MM**

MINI PLUG | FLOATING | UP TO 1.0M DIVING DEPTH

Mini plug for ultra-light fishing for trout, perch and chub. Despite its small size but thanks to its compact, bellied shape, the COR F16 can be cast long and precisely. Very active and variable presentation possible. Equipped with a single hook and a seductive feather.

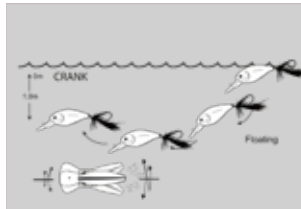

Art.-No.	Color	Length cm	Weight g	Content pc.
53-04441	yellow pellet	2.7	2.5	1
53-04442	green pellet	2.7	2.5	1
53-04443	copper pearl	2.7	2.5	1
53-04444	hot back	2.7	2.5	1

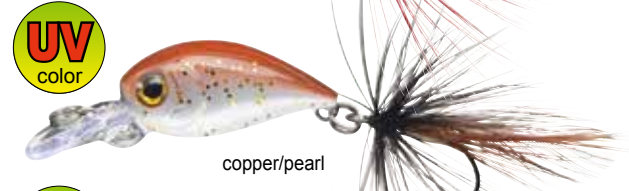

**COR SLS2 | 35MM**

MINI PLUG | SLOW SINKING | UP TO 0.8M DIVING DEPTH

Slowly sinking trout and perch plug with realistic body imitation of small bait fish. Suitable for silent waters and currents. Steady retrieving, changing speed and twitching in variable intervals – the COR SLS2 fits all.

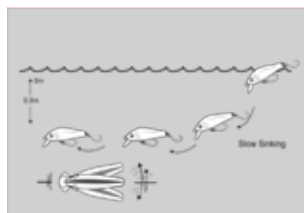

Art.-No.	Color	Length cm	Weight g	Content pc.
53-04461	black head	3.5	2.0	1
53-04462	copper pearl	3.5	2.0	1
53-04463	pale ayu	3.5	2.0	1
53-04464	hot ayu	3.5	2.0	1

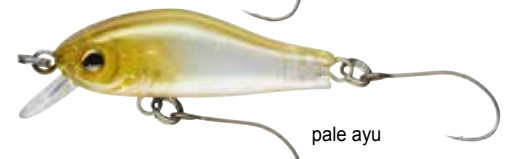

## LURES

### REALFISH DESIGN LURE SETS

## REALFISH DESIGN

Copying nature. Due to a special technique we succeeded in printing very realistic fish motives on the plugs, which in combination with the very lifelike action make these lures extraordinarily catchy. These plug sets have been especially composed for particular fields of application and fish species. Thanks to the selection of RealFish designs and the diverse actions many different fish species and water types can be targeted using these sets.

The RealFish Design plugs are equipped with sharp and durable trebles mounted on tough split rings.



#### „BABY BROWN TROUT DESIGN“ LURE SET

##### PLUG ASSORTMENT | BROWN TROUT DESIGN

3 plugs with RealFish design „baby brown trout“. Very catchy for perch, trout and chub as well as pike and zander in the warm season.

Art.-No.	Color	Lengths cm	Content Set pc.
53-00023	baby brown trout	5.0/5.5/6.5	3

#### „PERCH DESIGN“ LURE SET

##### PLUG ASSORTMENT | PERCH DESIGN

3 plugs with RealFish design „perch“. You can fish for every predator with these plugs in silent waters as well as currents.

Art.-No.	Color	Lengths cm	Content Set pc.
53-00026	perch	5.5/7.0/7.8	3

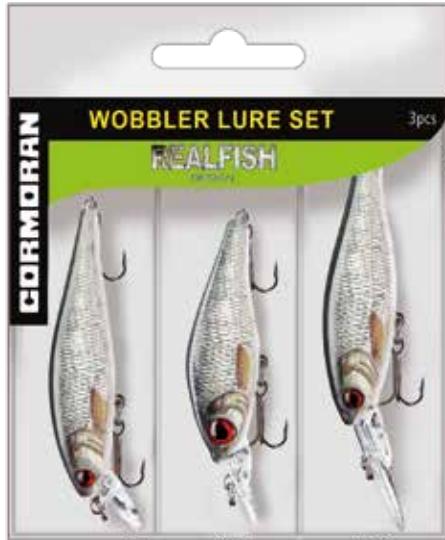

**„ROACH DESIGN“ LURE SET**

PLUG ASSORTMENT | ROACH DESIGN

3 plugs with RealFish design „roach“.  
Universal plugs for all situations and nearly all predators.

Art.-No.	Color	Lengths cm	Content Set pc.
53-00027	roach	5.5/6.5/7.0	3



**„MIXED DESIGN“ LURE SET 1**

PLUG ASSORTMENT | REALFISH DESIGN MIX

3 diverse plugs with 3 different RealFish designs: dying roach, brown trout and perch.  
Universally applicable plugs for all fields of application and nearly all kind of predators, especially trout and perch.

Art.-No.	Color	Lengths cm	Content Set pc.
53-00028	color mix 1	3.5/4.0/4.5	3



**„MIXED DESIGN“ LURE SET 2**

PLUG ASSORTMENT | REALFISH DESIGN MIX

3 identical floating all-round plugs with a diving depth of approx. 1.2m with 3 different RealFish designs: dying roach, brown trout and perch.  
Universally applicable plugs for all fields of application and nearly all kind of predators.

Art.-No.	Color	Lengths cm	Content Set pc.
53-00029	color mix 2	7.0/7.0/7.0	3

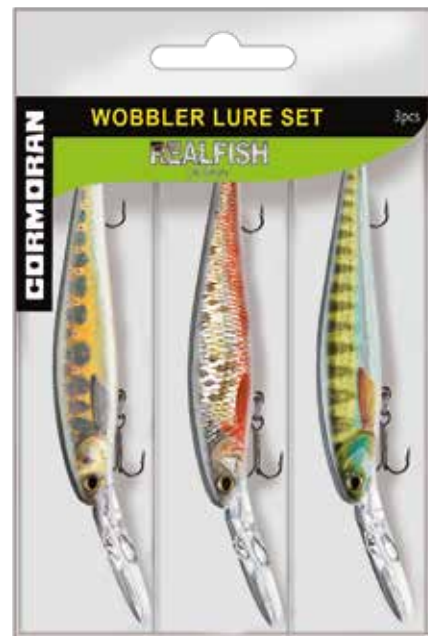

**„MIXED DESIGN“ LURE SET 3**

PLUG ASSORTMENT | REALFISH DESIGN MIX

3 identical floating deep runners with a diving depth of approx. 3.0m with 3 different RealFish designs: dying roach, brown trout and perch.  
Universally applicable plugs, especially for silent waters and all big predators like zander and especially pike.

Art.-No.	Color	Lengths cm	Content Set pc.
53-00030	color mix 3	9.0/9.0/9.0	3

## LURES

### TARGET FISH LURE SETS

These plug sets are particularly tailored for targeting pike, zander, perch and trout. Each set is delivered in a small box for easy transportation.



#### TARGET FISH LURE SET PIKE

PLUG ASSORTMENT | TARGET FISH: PIKE

Art.-No.	Lengths cm	Content Set pc.
53-00100	8.5/11.0/11.0	3

#### TARGET FISH LURE SET ZANDER

PLUG ASSORTMENT | TARGET FISH: ZANDER

Art.-No.	Lengths cm	Content Set pc.
53-00101	5.0/6.0/7.5/11.0	4



#### TARGET FISH LURE SET TROUT

PLUG ASSORTMENT | TARGET FISH: TROUT

Art.-No.	Lengths cm	Content Set pc.
53-00102	2.5/4.0/4.5/5.0	4

#### TARGET FISH LURE SET PERCH

PLUG ASSORTMENT | TARGET FISH: PERCH

Art.-No.	Lengths cm	Content Set pc.
53-00103	4.0/4.0/4.5/5.5	4

Art.-No.	Color	Size	Weight g	Content pc.
50-84001	silver	1	3.0	1
50-84002	silver	2	4.0	1
50-84003	silver	3	7.0	1
50-84004	silver	4	12.5	1
50-84005	silver	5	20.0	1

Art.-No.	Color	Size	Weight g	Content pc.
50-84011	gold	1	3.0	1
50-84012	gold	2	4.0	1
50-84013	gold	3	7.0	1
50-84014	gold	4	12.5	1
50-84015	gold	5	20.0	1

Art.-No.	Color	Size	Weight g	Content pc.
50-84021	copper	1	3.0	1
50-84022	copper	2	4.0	1
50-84023	copper	3	7.0	1
50-84024	copper	4	12.5	1
50-84025	copper	5	20.0	1

Art.-No.	Color	Size	Weight g	Content pc.
50-84031	silver/holographic	1	3.0	1
50-84032	silver/holographic	2	4.0	1
50-84033	silver/holographic	3	7.0	1
50-84034	silver/holographic	4	12.5	1
50-84035	silver/holographic	5	20.0	1

Art.-No.	Color	Size	Weight g	Content pc.
50-84041	gold/holographic	1	3.0	1
50-84042	gold/holographic	2	4.0	1
50-84043	gold/holographic	3	7.0	1
50-84044	gold/holographic	4	12.5	1
50-84045	gold/holographic	5	20.0	1

Art.-No.	Color	Size	Weight g	Content pc.
50-84051	silver/red dotted	1	3.0	1
50-84052	silver/red dotted	2	4.0	1
50-84053	silver/red dotted	3	7.0	1
50-84054	silver/red dotted	4	12.5	1
50-84055	silver/red dotted	5	20.0	1

Art.-No.	Color	Size	Weight g	Content pc.
50-84061	silver/red striped	1	3.0	1
50-84062	silver/red striped	2	4.0	1
50-84063	silver/red striped	3	7.0	1
50-84064	silver/red striped	4	12.5	1
50-84065	silver/red striped	5	20.0	1

Art.-No.	Color	Size	Weight g	Content pc.
50-84071	orange tiger	1	3.0	1
50-84072	orange tiger	2	4.0	1
50-84073	orange tiger	3	7.0	1
50-84074	orange tiger	4	12.5	1
50-84075	orange tiger	5	20.0	1

**BULLET**

**SPINNER**

Despite the range of plugs and plastic lures, spinners are still very popular. CORMORAN Bullet spinners are very well-balanced, rotate even at slow retrieving and are equipped with sharp, resistant trebles.



- Hook: CGS treble hook
- Waters: silent & current waters



# PREDATOR FISHING

## BULLET SINGLE

### SPINNER | WITH SINGLE HOOK

The most common CORMORAN spinners are also available with single hook.  
Especially for light fishing in trout ponds and streams.  
Also ideal for fishing for perch and chub.

- Hook: CGS single hook
- Waters: silent & current waters



Art.-No.	Color	Size	Weight g	Content pc.
50-85001	silver	1	3.0	1
50-85002	silver	2	4.0	1
50-85003	silver	3	7.0	1

Art.-No.	Color	Size	Weight g	Content pc.
50-85011	copper	1	3.0	1
50-85012	copper	2	4.0	1
50-85013	copper	3	7.0	1

Art.-No.	Color	Size	Weight g	Content pc.
50-85021	silver/red dotted	1	3.0	1
50-85022	silver/red dotted	2	4.0	1
50-85023	silver/red dotted	3	7.0	1

Art.-No.	Color	Size	Weight g	Content pc.
50-85031	silver/red striped	1	3.0	1
50-85032	silver/red striped	2	4.0	1
50-85033	silver/red striped	3	7.0	1

## BULLET SINGLE UL2

### ULTRALIGHT SPINNER | WITH SINGLE HOOK

Especially developed, size 0 ultra-light spinner with integrated swivel and single hook with feather.  
Perfectly made for fishing for trouts in ponds as well as streams. Also very catchy for perch and chub.

- Hook: CGS single hook
- Waters: silent & current waters
- Equipped with feather



Art.-No.	Color	Size	Weight g	Content pc.
50-87210	black/red	0	2.8	1
50-87220	chartreuse/black	0	2.8	1
50-87230	silver/holographic	0	2.8	1
50-87250	pearl	0	2.8	1
50-87270	red/blue	0	2.8	1



**TORO ULTRA LIGHT TROUT SPOON SET**

6 Toro UL spoons in handy lure box



**TORO UL SET 1**

TROUT SPOON ASSORTMENT

Art.-No.	Content Set pc.
50-88901	6



**TORO UL SET 2**

TROUT SPOON ASSORTMENT

Art.-No.	Content Set pc.
50-88902	6



**TORO UL SET 3**

TROUT SPOON ASSORTMENT

Art.-No.	Content Set pc.
50-88903	6



**TORO UL SET 4**

TROUT SPOON ASSORTMENT

Art.-No.	Content Set pc.
50-88904	6



**TORO UL SET 5**

TROUT SPOON ASSORTMENT

Art.-No.	Content Set pc.
50-88905	6

## LURES

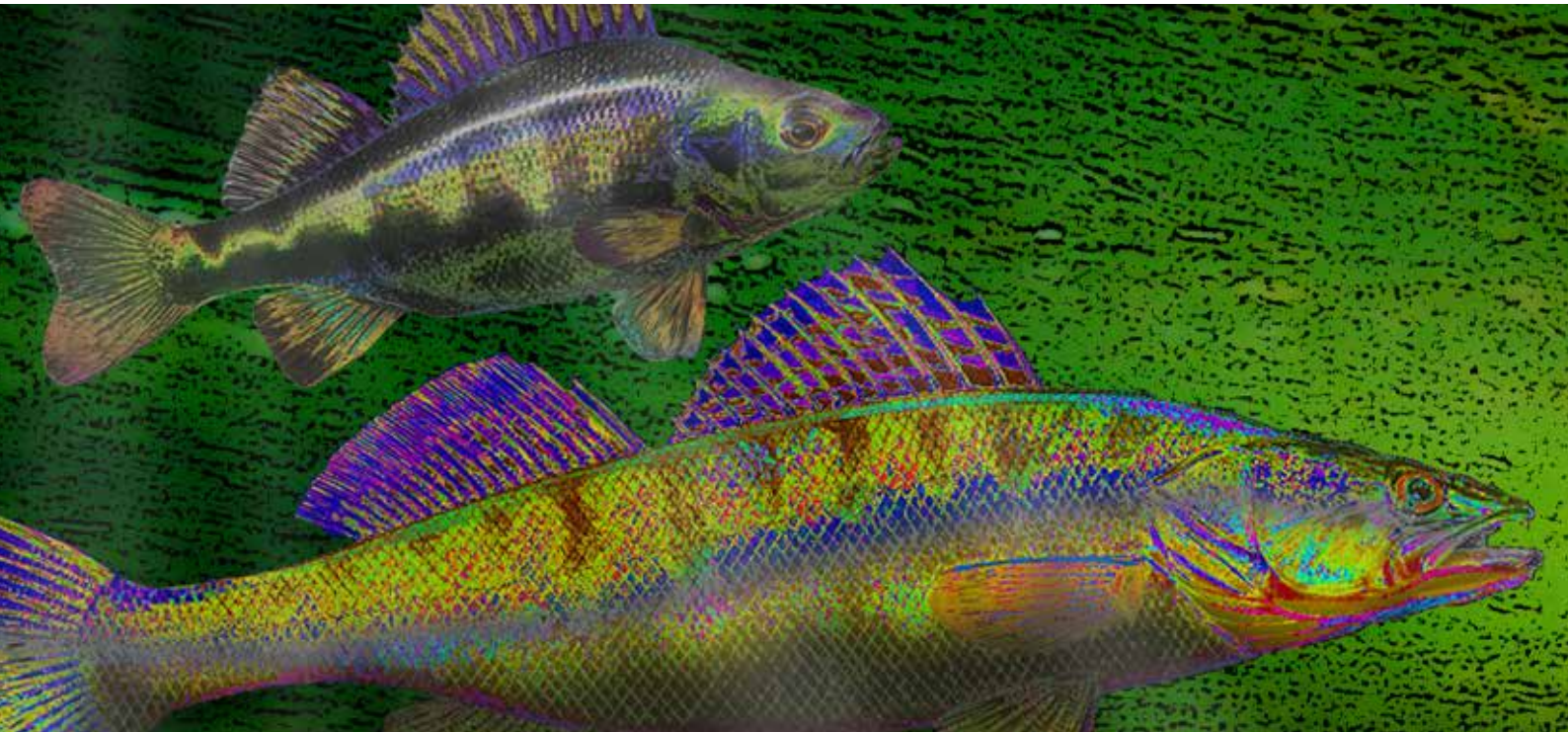

### ACTION FIN SHAD

**READY TO FISH**

Action Fin Shad – rigged on a jig hook.  
10cm: Jig hook 10g – total weight: 17g 13cm: Jig hook 15g – total weight: 29g

#### ACTION FIN SHAD | 100MM

#### ACTION FIN SHAD | 130MM

SHAD | READY TO FISH

SHAD | READY TO FISH

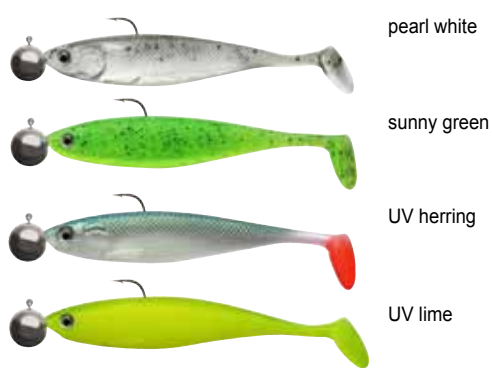
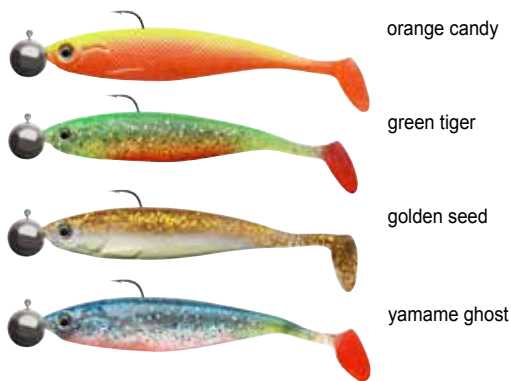

Art.-No.	Color	Length cm	Weight g	Content pc.	PU pc.
51-880010	orange candy	10.0	17.0	2	20
51-880310	green tiger	10.0	17.0	2	20
51-880410	golden seed	10.0	17.0	2	20
51-880510	yamame ghost	10.0	17.0	2	20
51-880610	pearl white	10.0	17.0	2	20
51-880710	sunny green	10.0	17.0	2	20
51-880910	UV herring	10.0	17.0	2	20
51-881110	UV lime	10.0	17.0	2	20

Art.-No.	Color	Length cm	Weight g	Content pc.	PU pc.
51-880030	orange candy	13.0	29.0	2	18
51-880330	green tiger	13.0	29.0	2	18
51-880430	golden seed	13.0	29.0	2	18
51-880530	yamame ghost	13.0	29.0	2	18
51-880630	pearl white	13.0	29.0	2	18
51-880730	sunny green	13.0	29.0	2	18
51-880930	UV herring	13.0	29.0	2	18
51-881130	UV lime	13.0	29.0	2	18



**CRAZY FIN SHAD**

**READY TO FISH**

Crazy Fin Shad - rigged on a jig hook.  
10cm: Jig hook 10g - total weight: 16g 13cm: Jig hook 15g - total weight: 27g

**CRAZY FIN SHAD | 100MM**

**CRAZY FIN SHAD | 130MM**

SHAD | READY TO FISH

SHAD | READY TO FISH

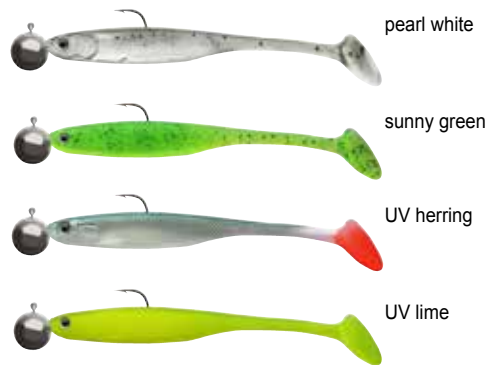

Art.-No.	Color	Length cm	Weight g	Content pc.	PU pc.
51-890010	orange candy	10.0	16.0	2	20
51-890310	green tiger	10.0	16.0	2	20
51-890410	golden seed	10.0	16.0	2	20
51-890510	yamame ghost	10.0	16.0	2	20
51-890610	pearl white	10.0	16.0	2	20
51-890710	sunny green	10.0	16.0	2	20
51-890910	UV herring	10.0	16.0	2	20
51-891110	UV lime	10.0	16.0	2	20

Art.-No.	Color	Length cm	Weight g	Content pc.	PU pc.
51-890030	orange candy	13.0	27.0	2	18
51-890330	green tiger	13.0	27.0	2	18
51-890430	golden seed	13.0	27.0	2	18
51-890530	yamame ghost	13.0	27.0	2	18
51-890630	pearl white	13.0	27.0	2	18
51-890730	sunny green	13.0	27.0	2	18
51-890930	UV herring	13.0	27.0	2	18
51-891130	UV lime	13.0	27.0	2	18

## BOOMS

Still one of the most used accessories for carp and feeder fishing. Of course these booms are also applicable for normal ground fishing



### FLEXI FEEDER BOOM

CURVED | WITH 360° SWIVEL

Flexible, curved Anti-Tangle Boom with swivel, which is rigged rotatable in all directions.

Art.-No.	Color	Length cm	Type	Content pc.
49-52013	sand	13.0	curved	2

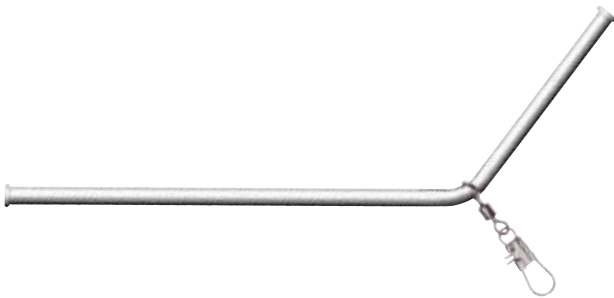

### METAL ANTI-TANGLE BOOM

CURVED | WITH SWIVEL

Strong, curved Anti-Tangle Boom with swivel.

Art.-No.	Color	Length cm	Type	Content pc.
49-52412	silver	12.0	curved	3

### PRO CARP RIGBOX

Specially developed for straight storage of approx. 15 carp rigs. Fast and secure handling. With 2 separate mini boxes, where bait needles and hooks can be stored.

Art.-No.	Size cm	Content pc.
11-10104	34.5x9x2.6	1

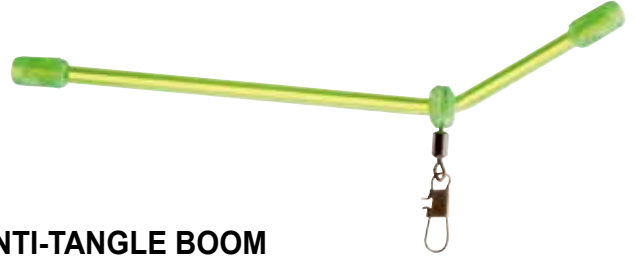

### ANTI-TANGLE BOOM

CURVED | WITH SWIVEL

Made of plastic, with swivel.

Art.-No.	Color	Length cm	Type	Content pc.
48-51110	green	10.0	curved	3
48-51112	green	12.0	curved	3



### ANTI-TANGLE BOOM

CURVED | WITH SNAP

Universal, curved Anti-Tangle Boom for ground, feeder and carp fishing. With line-protecting butt caps.

Art.-No.	Color	Length cm	Type	Content pc.
49-53105	black	5.0	curved	3
49-53110	black	10.0	curved	3
49-53115	black	15.0	curved	3
49-53125	black	25.0	curved	3



Delivered without rigs.

**HAIR RIGS**



**PRO CARP CLASSIC BOILIE RIG**

WITH CARP HOOK T4 (TEFLON COATED)

Extremely wide field of application – nearly every carp bait can be mounted to the Classic Rig. Due to the mounted Rolling Swivel, this rig can be fished with an inline lead as well as with a Safety Clip. The sinking leader material is nearly invisible for carps under water.

Art.-No.	Rig Length cm	Hook Size	Strength lb	Content pc.
11-02300-1	18.0	1	25	2
11-02300-2	18.0	2	25	2
11-02300-4	18.0	4	25	2
11-02300-6	18.0	6	25	2

**PRO CARP HIGH ABRASION RIG**

WITH CARP HOOK T4 (TEFLON COATED)

If you are confronted with many mussels, plants or branches in the water, this rig is exactly what you need. Due to the high abrasion resistance you retain the complete breaking strength even in difficult situations. Also perfectly suitable for fishing in currents.

Art.-No.	Rig Length cm	Hook Size	Strength lb	Content pc.
11-02302-1	18.0	1	35	2
11-02302-2	18.0	2	35	2
11-02302-4	18.0	4	35	2
11-02302-6	18.0	6	35	2

**PRO CARP LINE ALIGNER RIG**

WITH CARP HOOK T3 (TEFLON COATED)

The line aligner rig provides an unique hook feature. Due to the downward shaped shrink tube it is difficult for the carp to spit out the absorbed bait and hook. Use boilies, pop-ups, pellets and particles with this rig.

Art.-No.	Rig Length cm	Hook Size	Strength lb	Content pc.
11-02301-1	18.0	1	25	2
11-02301-2	18.0	2	25	2
11-02301-4	18.0	4	25	2
11-02301-6	18.0	6	25	2

**PRO CARP CLASSIC RIG**

WITH CARP HOOK T4 (TEFLON COATED)

A classical rig, combined with a modern absorption at the main line. More and more popular with quick-change swivel. Changing the rig because of an blunt hook or another bait is possible as fast as never before. The leader and the hook are fitting with nearly all kinds of waters and baits.

Art.-No.	Rig Length cm	Hook Size	Strength lb	Content pc.
11-02303-1	18.0	1	25	2
11-02303-2	18.0	2	25	2
11-02303-4	18.0	4	25	2
11-02303-6	18.0	6	25	2



**PRO CARP COMBI RIG**

WITH CARP HOOK T6 (TEFLON COATED)

The Combi Rig combines stiffness for the cast and natural behavior of the bait. The fluorocarbon material prevents the rig from rolling over and is nearly invisible under water. The used soft leader material ensures an easy sucking of the bait. With to the installation of a Tungsten Putty on the leader you get an excellent pop-up rig.

Art.-No.	Rig Length cm	Hook Size	Strength lb	Content pc.
11-02305-2	19.0	2	25	2
11-02305-4	19.0	4	25	2
11-02305-6	19.0	6	25	2

**PRO CARP CLASSIC BOILIE RIG ST**

WITH CARP HOOK T4 (TEFLON COATED)

Completely protected knots and an extremely good hooking rate are ensured by the used shrink tubes. The leader and the hook are suitable for all water types. The swivel size matches all common safety clips and inline leads.

Art.-No.	Hook Size	Strength lb	Content pc.
11-02320-2	2	35	2
11-02320-4	4	25	2
11-02320-6	6	25	2



**PRO CARP POP-UP BOILIE RIG**

WITH CARP HOOK T2 (TEFLON COATED)

This rig is perfectly suitable if a swimming boilie is necessary. The long leg of the used T2 hook guarantees a natural movement of the bait under water and can be soaked in by the carp easily. Due to the additional Pro Carp Tungsten Putty you can adjust the pop-up's height above the ground.

Art.-No.	Rig Length cm	Hook Size	Strength lb	Content pc.
11-02306-2	19.0	2	25	2
11-02306-4	19.0	4	25	2
11-02306-6	19.0	6	25	2

**PRO CARP COATED RIG ST**

WITH CARP HOOK T6 (TEFLON COATED)

Coated rigs have been proven to represent the ultimate choice for pop-up rigs. Just mount a small amount of Tungsten at the spot between hard and soft material and floating boilies are presented right above the ground. Like this the hook bait is somewhat highlighted from the ground bait and gets sucked in instantly from curious carps. Due to the extremely supple tip, also cautious fishes don't feel any resistance at sucking of the bait. The swivel size matches all common safety clips and inline leads.

Art.-No.	Hook Size	Strength lb	Content pc.
11-02323-2	2	35	2
11-02323-4	4	25	2
11-02323-6	6	25	2

## BIG TROUT SBIROLINO

### FLOATING

Classical sbirolino for active surface fishing. The milky-clear body avoids dazzling and is hard to recognize for the fishes.

Art.-No.	Color	Weight g	Type	Content pc.
79-62110	white	10.0	floating	1
79-62112	white	12.0	floating	1
79-62115	white	15.0	floating	1
79-62120	white	20.0	floating	1
79-62125	white	25.0	floating	1
79-62130	white	30.0	floating	1
79-62140	white	40.0	floating	1

## BIG TROUT SBIROLINO

### SLOW SINKING

Slim, slowly sinking sbirolino with transparent body. The different weights take the sbirolino to different water depths and enable you to successfully scan the middle water.

Art.-No.	Color	Weight g	Type	Content pc.
79-62310	clear	10.0	slow sinking	1
79-62312	clear	12.0	slow sinking	1
79-62315	clear	15.0	slow sinking	1
79-62320	clear	20.0	slow sinking	1
79-62325	clear	25.0	slow sinking </td <td>1</td>	1
79-62330	clear	30.0	slow sinking	1
79-62340	clear	40.0	slow sinking	1

## BIG TROUT SBIROLINO

### SINKING

Slim, sinking sbirolino with clear body, which makes this sbirolino almost invisible. The different weights care for a swiftly sinking of the sbirolinos to enable scanning of deeper water areas.

Art.-No.	Color	Weight g	Type	Content pc.
79-62510	clear	10.0	sinking	1
79-62515	clear	15.0	sinking	1
79-62520	clear	20.0	sinking	1
79-62525	clear	25.0	sinking	1
79-62530	clear	30.0	sinking	1

## NITRO BAITFORMER

### DOUGH FORMER

With the BaitFormer the trout dough can be formed easily, quickly and ideally.

- Form the dough portion around the hook
- Put the dough in the mould
- Close the BaitFormer
- Open the BaitFormer and take the shaped dough out of the BaitFormer

Art.-No.	Content pc.
57-09001	1



GLASS BEADS



GLASS BEAD ASSORTMENT

CLEAR | Ø 4-6MM

Range of transparent stopper glass beads.  
10x Ø 4mm  
10x Ø 5mm  
10x Ø 6mm

Art.-No.	Color	Ø mm	Content Set pc.
49-09301	clear	4-6	30

GLASS BEAD ASSORTMENT

RED | Ø 4-6MM

Range of red stopper glass beads.  
10x Ø 4mm  
10x Ø 5mm  
10x Ø 6mm

Art.-No.	Color	Ø mm	Content Set pc.
49-09300	red	4-6	30



SOFT BEAD ASSORTMENT

FLUO-YELLOW | OVAL | Ø 4-6MM

Range of oval, fluo-yellow soft beads.  
10x Ø 4mm  
10x Ø 5mm  
10x Ø 6mm

Art.-No.	Color	Ø mm	Content Set pc.
49-09200	fluo yellow	4-6	30

SOFT BEAD ASSORTMENT

OLIVE GREEN | ROUND | Ø 5-7MM

Range of round, olive soft beads.  
10x Ø 5mm  
10x Ø 6mm  
10x Ø 7mm

Art.-No.	Color	Ø mm	Content Set pc.
49-09201	olive green	5-7	30



**SILICONE STOPPER ASSORTMENTS**

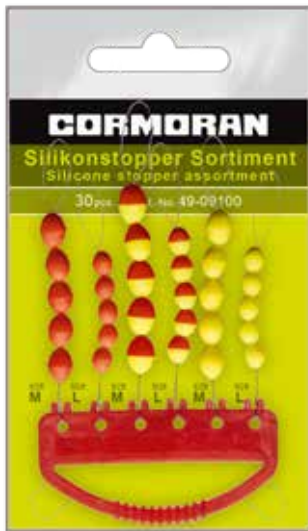

**SILICONE STOPPER ASSORTMENT**

YELLOW / RED

5 stoppers in size M and L each, in colors red, yellow and yellow/red.

Art.-No.	Color	Size	Content Set pc.
49-09100	yellow/red	M+L	30



**SILICONE STOPPER ASSORTMENT**

CLEAR / WHITE

5 stoppers in different shapes in size M and L each, in colors semi-transparent and white

Art.-No.	Color	Size	Content Set pc.
49-09101	clear/white	M+L	30



**SILICONE STOPPER ASSORTMENT**

OLIVE GREEN

5 stoppers in different shapes in size M and L each, in olive.

Art.-No.	Color	Size	Content Set pc.
49-09102	olive green	M+L	30



**SILICONE STOPPER ASSORTMENT**

FLUO-YELLOW

5 stoppers in different shapes in size M and L each, in fluo-green yellow.

Art.-No.	Color	Size	Content Set pc.
49-09103	fluo yellow	M+L	30

**SILICONE STOPPER ASSORTMENTS**

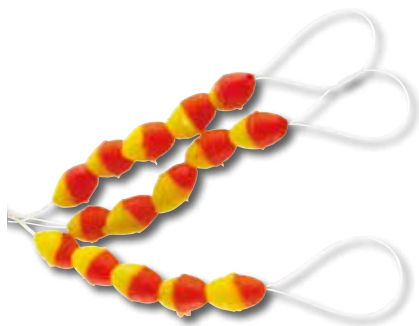

**SILICONE STOPPERS**

**YELLOW / RED**

Universal silicone stoppers, grippy and super soft.

Art.-No.	Color	Size	Content pc.
49-02312	yellow/red	M	15
49-02313	yellow/red	L	15
49-02314	yellow/red	XL	15

**SILICONE STOPPERS**

**CLEAR**

Slip resistant silicone stoppers. Can be used universally.

Art.-No.	Color	Size	Content pc.
49-02011	clear	S	15
49-02012	clear	M	15
49-02013	clear	L	15
49-02014	clear	XL	15

**FLOAT RINGS & BEADS**

**SILICONE FLOAT RING ASSORTMENT**

**BOX SET | SMALL & MEDIUM SIZE**

5 compartments with different sized float rings in different colors. Highly stretchable and tear-proof.

Art.-No.	Size
49-09010	S
49-09011	M



**FLOAT RING ASSORTMENT**

**BOX SET | SMALL SIZE**

5 compartments with different sized float rings in different colors.

Art.-No.	Size
49-09001	S



**GLASS BEAD ASSORTMENT**

**BOX SET | 5 COLORS | Ø 4MM**

5 compartments with different colored stopper glass beads.

Art.-No.	Ø mm	Content Set pc.
49-09030	4	100



**GLASS BEAD ASSORTMENT**

**BOX SET | RED | Ø 3-7MM**

5 compartments with red stopper glass beads with Ø 3-7mm – 20 pieces each.

Art.-No.	Color	Ø mm	Content Set pc.
49-09040	red	3-7	100



**SOFT BEAD ASSORTMENT**

**BOX SET | FLUO-GREEN | Ø 4-8MM**

5 compartments with oval, fluo-green soft beads in different sizes.

Art.-No.	Color	Ø mm	Content Set pc.
49-09020	fluo green	4-8	50



## LIGHTSTICK GLOW STICKS

This Lightstick glow sticks are characterized by a very high light intensity and a long burning time. Instead of liquids they are based on powder.

### LIGHTSTICK GLOW STICK

STANDARD SIZE | Ø 4.5MM

Art.-No.	Color	Size mm	Content pc.
49-08005	yellow	37x4.5	2
49-08006	red	37x4.5	2
49-08007	blue	37x4.5	2

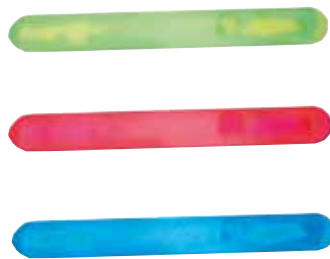

### LIGHTSTICK GLOW STICK

MINI SIZE | Ø 3.0MM

Art.-No.	Color	Size mm	Content pc.
49-08009	yellow	25x3	2



### LIGHTSTICK GLOW STICK CLIP-ON

FOR TIP DIAMETERS 3.3-3.7MM

Glow stick with integrated mounting for the rod tip.



Art.-No.	Color	Size mm	Content pc.
49-08001	yellow	37x4.5	2

EEL BELLS



LED ROD BELL | DOUBLE

With illuminating diode and plastic fast clip. Batteries are included in delivery.

Art.-No.	Color LED	Content pc.
49-80001	yellow	1



ROD BELL | SINGLE

With special, save plastic thread and glow stick holder.

Art.-No.	Content pc.
49-80003	1



ROD BELL | DOUBLE

With special, save plastic thread and glow stick holder.

Art.-No.	Content pc.
49-80004	1



ROD BELL | DOUBLE

With save fast plastic clip.

Art.-No.	Content pc.
49-80005	1



ROD BELL | DOUBLE

With special, fast metal clip.

Art.-No.	Content pc.
49-80007	1



ROD BELL | SINGLE

With crocodile clip.

Art.-No.	Content pc.
49-80006	1



ROD BELL | DOUBLE

With crocodile clip.

Art.-No.	Content pc.
49-80010	1

BITE INDICATORS

CLIP-ON BITE INDICATOR

NOTILUCENT | WITH GLOW STICK INSERT

This bite indicator is ideally suited for fishing in still and slow flowing waters.



Art.-No.	Size cm	Content pc.
48-10042	9.5	1

**MAGMIX GROUNDBAIT MIXES**



The Magmix bait mixtures have been developed by specialists of the international competition scene and are specially designed for the requested target fish respectively fishing method. The feed is very active in the water and attracts fish even from great distances to the feeding place.

The Magmix's combination of feeding stimulating attractors and little satiating, chipped particles and superior meals makes the fish search actively for feed and stay longer in the fishing area.

**Preparation:**  
Mix the feed in short terms, 3-4 times within 15-20 minutes, with small amounts of water and let it soak. Then push it through a sieve. Adding maggots, casters and worms makes it even more catchy. Keep in a cool and dry place! Minimum durability: 12 month



**MAGMIX CARP**

GROUNDBAIT MIX

Art.-No.	Description	Content kg
59-60000	Carp	1.0
59-62000	Carp	3.0



**MAGMIX FEEDER**

GROUNDBAIT MIX

Art.-No.	Description	Content kg
59-60004	Feeder	1.0
59-62004	Feeder	3.0



**MAGMIX ROACH**

GROUNDBAIT MIX

Art.-No.	Description	Content kg
59-60001	Roach	1.0



**MAGMIX BREAM SPECIAL**

GROUNDBAIT MIX

Art.-No.	Description	Content kg
59-60002	Bream special	1.0



**MAGMIX MATCH SPECIAL**

GROUNDBAIT MIX

Art.-No.	Description	Content kg
59-60003	Match Special	1.0

**MAGMIX CORN PELLETS**

GROUNDBAIT

Corn pellets made of sweet, roasted corn can be fed with a catapult or by hand around the hook bait. These pellets dissolve in water very quickly and transmit the very attractive scent of roasted corn directly to the water. Thereby the pellets resolve into smallest particles, that can not satiate the attracted fish.

Art.-No.	Color	Content kg
59-30100	yellow	1.0



READY TIED FLOAT RIGS



READY TIED FLOAT RIG M|46-26002

Art.-No.	Strength g	Content pc.
46-26002	1.4	1



READY TIED FLOAT RIG M|46-26003

Art.-No.	Strength g	Content pc.
46-26003	1.0	1



READY TIED FLOAT RIG M|46-26004

Art.-No.	Strength g	Content pc.
46-26004	1.0	1



READY TIED FLOAT RIG M|46-26005

Art.-No.	Strength g	Content pc.
46-26005	2.0	1



READY TIED FLOAT RIG M|46-26006

Art.-No.	Strength g	Content pc.
46-26006	1.25	1



READY TIED FLOAT RIG M|46-26007

Art.-No.	Strength g	Content pc.
46-26007	0.75	1



READY TIED FLOAT RIG M|46-26008

Art.-No.	Strength g	Content pc.
46-26008	1.0	1



READY TIED FLOAT RIG M|46-26011

Art.-No.	Strength g	Content pc.
46-26011	0.75	1

FLOATS



M 250 M 251 M 252 M 254 M 255

FLOAT M|250

INLINE FLOAT | WITH GLOW STICK INSERT

Glow stick inline float.

Art.-No.	Strength g	Content pc.
43-25006	6.0	1
43-25008	8.0	1
43-25010	10.0	1
43-25012	12.0	1

FLOAT M|251

INLINE FLOAT | WITH GLOW STICK INSERT

Torpedo glow stick inline float.

Art.-No.	Strength g	Content pc.
43-25110	10.0	1
43-25115	15.0	1
43-25120	20.0	1
43-25130	30.0	1

FLOAT M|252

INLINE FLOAT | WITH GLOW STICK INSERT

Compact glow stick inline float

Art.-No.	Strength g	Content pc.
43-25206	6.0	1
43-25208	8.0	1
43-25210	10.0	1

FLOAT M|254

SLIDING FLOAT | WITH GLOW STICK INSERT

Slim glow stick float with eyelet.

Art.-No.	Strength g	Content pc.
43-25403	3.0	1
43-25405	5.0	1
43-25407	7.0	1

FLOAT M|255

SLIDING FLOAT | WITH GLOW STICK INSERT

Classical glow stick float with swivel.

Art.-No.	Strength g	Content pc.
43-25504	4.0	1
43-25506	6.0	1
43-25508	8.0	1



M 260 M 261 M 262 M 265 M 266

**FLOAT M|260**

SLIDING FLOAT | WITH GLOW STICK HOLDER

All-round glow stick float.

Art.-No.	Strength g	Content pc.
43-26003	3.0	1
43-26005	5.0	1
43-26007	7.0	1

**FLOAT M|261**

SLIDING FLOAT | WITH GLOW STICK HOLDER

Slim glow stick float.

Art.-No.	Strength g	Content pc.
43-26103	3.0	1
43-26105	5.0	1
43-26107	7.0	1

**FLOAT M|262**

SLIDING FLOAT | WITH GLOW STICK HOLDER

Slim glow stick float with low center of gravity.

Art.-No.	Strength g	Content pc.
43-26203	3.0	1
43-26205	5.0	1
43-26207	7.0	1

**FLOAT M|265**

SLIDING FLOAT | WITH GLOW STICK HOLDER

Slim glow stick float with swivel.

Art.-No.	Strength g	Content pc.
43-26503	3.0	1
43-26504	4.0	1
43-26505	5.0	1

**FLOAT M|266**

FIXED FLOAT | WITH GLOW STICK HOLDER

All-round glow stick pole float.

Art.-No.	Strength g	Content pc.
43-26603	3.0	1
43-26605	5.0	1



M 283 M 287

**COARSE FLOAT M|283**

SLIDING FLOAT

Slim coarse float with swivel and thick antenna.

Art.-No.	Strength g	Content pc.
43-28303	3.0	1
43-28304	4.0	1
43-28305	5.0	1

**SPECIMEN FLOAT M|287**

INLINE FLOAT

Slim specimen inline float.

Art.-No.	Strength g	Content pc.
43-28706	6.0	1
43-28708	8.0	1
43-28710	10.0	1



M 290-4 M 291-5 M 293-8

**ZANDER FLOAT M|290**

SLIDING FLOAT | WITH GLOW STICK HOLDER

Egg-shaped zander float for dead baitfish.

Art.-No.	Strength g	Content pc.
43-29004	4.0	1

**ZANDER FLOAT M|291**

INLINE FLOAT | WITH GLOW STICK HOLDER

With glow stick insert  
Compact inline zander float for dead baitfish.

Art.-No.	Strength g	Content pc.
43-29105	5.0	1

**ZANDER FLOAT M|293**

SLIDING FLOAT | WITH GLOW STICK HOLDER

With glow stick holder  
Slim zander float for dead baitfish.

Art.-No.	Strength g	Content pc.
43-29308	8.0	1

HOOKS



**PROFILINE SNELLED HOOKS**

10 ready leaders per pack

**PROFILINE CARP HOOKS M|210G**

Length: 70cm,  
color: gold

Art.-No.	Color	Hook Size	Rig Length cm	Ø Line mm	Content pc.
70-210G033-1	gold	1	70	0.33	10
70-210G030-2	gold	2	70	0.30	10
70-210G027-4	gold	4	70	0.27	10
70-210G025-6	gold	6	70	0.25	10
70-210G023-8	gold	8	70	0.23	10



**PROFILINE CARP HOOKS M|211S**

Length: 70cm,  
color: black

Art.-No.	Color	Hook Size	Rig Length cm	Ø Line mm	Content pc.
70-211S033-1	black	1	70	0.33	10
70-211S030-2	black	2	70	0.30	10
70-211S030-4	black	4	70	0.30	10
70-211S025-6	black	6	70	0.25	10
70-211S025-8	black	8	70	0.25	10



**PROFILINE WORM HOOKS M|299B**

Length: 50cm,  
color: bronzed

Art.-No.	Color	Hook Size	Rig Length cm	Ø Line mm	Content pc.
70-299B025-4	bronzed	4	50	0.25	10
70-299B025-6	bronzed	6	50	0.25	10
70-299B022-8	bronzed	8	50	0.22	10
70-299B01810	bronzed	10	50	0.18	10
70-299B01612	bronzed	12	50	0.16	10





**PROFILINE MAGGOT HOOKS M|280N**

Length: 50cm,  
color: nickel



Art.-No.	Color	Hook Size	Rig Length cm	Ø Line mm	Content pc.
70-280N016-8	nickel	8	50	0.16	10
70-280N01610	nickel	10	50	0.16	10
70-280N01410	nickel	10	50	0.14	10
70-280N01612	nickel	12	50	0.16	10
70-280N01412	nickel	12	50	0.14	10
70-280N01214	nickel	14	50	0.12	10
70-280N01216	nickel	16	50	0.12	10
70-280N01016	nickel	16	50	0.10	10
70-280N01018	nickel	18	50	0.10	10

**PROFILINE EEL HOOKS M|200B**

Length: 50cm,  
color: bronzed



Art.-No.	Color	Hook Size	Rig Length cm	Ø Line mm	Content pc.
70-200B035-1	bronzed	1	50	0.35	10
70-200B035-2	bronzed	2	50	0.35	10
70-200B035-3	bronzed	3	50	0.35	10
70-200B035-4	bronzed	4	50	0.35	10
70-200B030-5	bronzed	5	50	0.30	10
70-200B030-6	bronzed	6	50	0.30	10
70-200B028-7	bronzed	7	50	0.28	10
70-200B030-8	bronzed	8	50	0.30	10
70-200B02510	bronzed	10	50	0.25	10

**PROFILINE CORN HOOKS M|250G**

Length: 70cm,  
color: gold



Art.-No.	Color	Hook Size	Rig Length cm	Ø Line mm	Content pc.
70-250G025-4	gold	4	70	0.25	10
70-250G022-6	gold	6	70	0.22	10
70-250G020-8	gold	8	70	0.20	10
70-250G01810	gold	10	70	0.18	10
70-250G01612	gold	12	70	0.16	10

**PROFILINE PASTE HOOKS M|261N**

Length: 50cm,  
color: nickel



Art.-No.	Color	Hook Size	Rig Length cm	Ø Line mm	Content pc.
70-261N030-2	nickel	2	50	0.30	4
70-261N025-4	nickel	4	50	0.25	4
70-261N025-6	nickel	6	50	0.25	4
70-261N022-8	nickel	8	50	0.22	4

**PROFILINE ZANDER HOOKS M|240N**

Length: 70cm,  
color: nickel



Art.-No.	Color	Hook Size	Rig Length cm	Ø Line mm	Content pc.
70-240N025-2	nickel	2/0	70	0.25	10
70-240N025-1	nickel	1/0	70	0.25	10
70-240N024-1	nickel	1	70	0.23	10

**PROFILE COARSE HOOKS M|220N**



Length: 60cm,  
color: nickel

Art.-No.	Color	Hook Size	Rig Length cm	Ø Line mm	Content pc.
70-220N020-8	nickel	8	60	0.20	10
70-220N01810	nickel	10	60	0.18	10
70-220N01612	nickel	12	60	0.16	10
70-220N01414	nickel	14	60	0.14	10
70-220N01216	nickel	16	60	0.12	10

**PROFILE ZANDER RYDER HOOKS M|245B**



bound to CoraStrong  
Length: 70cm,  
color: bronzed

Art.-No.	Color	Hook Size	Rig Length cm	Ø Line mm	Content pc.
70-245B010-2	bronzed	2	70	0.10	2
70-245B008-4	bronzed	4	70	0.08	2
70-245B008-6	bronzed	6	70	0.08	2

**PROFILE TROUT HOOKS M|230N**



Length: 70cm,  
color: nickel

Art.-No.	Color	Hook Size	Rig Length cm	Ø Line mm	Content pc.
70-230N026-4	nickel	4	70	0.26	10
70-230N026-6	nickel	6	70	0.26	10
70-230N020-6	nickel	6	70	0.20	10
70-230N025-8	nickel	8	70	0.25	10
70-230N020-8	nickel	8	70	0.20	10
70-230N02010	nickel	10	70	0.20	10
70-230N02012	nickel	12	70	0.20	10

**PROFILE ALL-ROUND HOOKS M|290B**



Length: 60cm,  
color: bronzed

Art.-No.	Color	Hook Size	Rig Length cm	Ø Line mm	Content pc.
70-290B027-2	bronzed	2	60	0.27	10
70-290B025-4	bronzed	4	60	0.25	10
70-290B023-6	bronzed	6	60	0.23	10
70-290B023-8	bronzed	8	60	0.23	10
70-290B02010	bronzed	10	60	0.20	10
70-290B01812	bronzed	12	60	0.18	10

**PROFILE ALL-ROUND HOOK ASSORTMENT M|299SO**



Length: 60cm,  
color: bronzed  
Sizes 4, 6, 8, 10, 12 - 2  
hooks each

Art.-No.	Color	Hook Size	Rig Length cm	Content Set pc.
70-299SO	bronzed	4-12	60	10



## CORLOCK SNAPS AND SWIVELS

Strong and reliable snap made of spring steel, which can easily be opened and closed also with wet fingers.

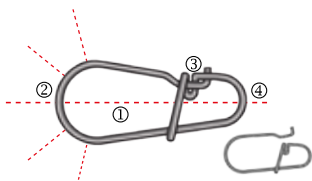

Original size



### Symmetric design for a perfect balance

The extra-wide curve cares for an optimal lure action.

Fitting for all lures

Super strong and reliable lock. Easy to operate

Narrow curve to the swivel, leader loop knot or main line to keep the knot in a centered position

## CORLOCK SWIVEL



The Corlock swivels have been developed for specialists, who need to rely on their swivel in every situation.



## CORLOCK SNAP



Especially designed for spin fishing. The extra-wide curve considerably supports the lure action.



Art.-No.	Swivel Size	Strength kg	Content pc.
80-70012	12	10.0	8
80-70010	10	12.0	7
80-70008	8	16.0	7
80-70006	6	21.0	6
80-70004	4	30.0	6

Art.-No.	Swivel Size	Length mm	Strength kg	Content pc.
80-70211	11	11	12.0	10
80-70213	13	13	21.0	10
80-70215	15	15	30.0	10

## CORMORAN QUALITY SWIVELS



### EASY SNAP SWIVEL



Black-nickel, strong.

Art.-No.	Color	Swivel Size	Strength kg	Content pc.
80-10014	black-nickel	14	4.0	10
80-10012	black-nickel	12	5.0	10
80-10010	black-nickel	10	7.0	10
80-10008	black-nickel	8	9.0	8
80-10006	black-nickel	6	11.0	8
80-10004	black-nickel	4	12.0	6
80-10002	black-nickel	2	13.0	6

### HOOKED SNAP SWIVEL



Gunmetal, very strong.

Art.-No.	Color	Swivel Size	Strength kg	Content pc.
80-00014	bronzed	14	22.0	8
80-00012	bronzed	12	22.0	8
80-00010	bronzed	10	30.0	7
80-00008	bronzed	8	30.0	7
80-00006	bronzed	6	37.0	6
80-00004	bronzed	4	37.0	6
80-00002	bronzed	2	41.0	5

### CORTEST SWIVEL



Bronzed, very strong.

Art.-No.	Color	Swivel Size	Strength kg	Content pc.
80-07012	bronzed	12	22.0	8
80-07010	bronzed	10	30.0	7
80-07008	bronzed	8	30.0	7
80-07006	bronzed	6	37.0	6

### KNOTLESS LINE CONNECTOR



Especially developed for braided lines. The line connector enables to connect a swivel with a braided line within seconds with retaining 100% breaking strength at the same time. Made of stainless steel.

Art.-No.	Size	Strength kg	Content pc.
80-15202	M	14.0	10
80-15201	L	32.0	10
80-15200	XL	65.0	10

### HOOKED SNAP



Gunmetal, strong.

Art.-No.	Color	Swivel Size	Strength kg	Content pc.
80-14001	bronzed	1	13.0	10
80-14002	bronzed	2	18.0	10
80-14003	bronzed	3	28.0	10

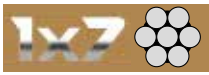

## 1X7 WIRE LEADERS

Affordable and highly robust 1x7 steel wire.



### 1X7 WIRE LEADER

WITH SWIVEL AND SNAP

Very affordable steel wire with swivel and snap, which can be applied universally at predator fishing.



### 1X7 WIRE LEADER

WITH LOOP AND SNAP

Very affordable steel wire with loop and snap, which can be applied universally.

Art.-No.	Color	Rig Length cm	Strength kg	Content pc.
75-22060	brown	50.0	6.0	2
75-22090	brown	50.0	9.0	2
75-22120	brown	50.0	12.0	2
75-22150	brown	50.0	15.0	2

Art.-No.	Color	Rig Length cm	Strength kg	Content pc.
75-23060	brown	20.0	6.0	2
75-23090	brown	20.0	9.0	2
75-23120	brown	20.0	12.0	2
75-23150	brown	20.0	15.0	2
75-24060	brown	30.0	6.0	2
75-24090	brown	30.0	9.0	2
75-24120	brown	30.0	12.0	2
75-24150	brown	30.0	15.0	2
75-25060	brown	70.0	6.0	2
75-25090	brown	70.0	9.0	2
75-25120	brown	70.0	12.0	2
75-25150	brown	70.0	15.0	2



### 1X7 WIRE LEADER

WITH LOOP AND SINGLE HOOK

Very affordable steel wire with loop and single hook.

Art.-No.	Color	Rig Length cm	Hook Size	Strength kg	Content pc.
75-26090	brown	50.0	2	9.0	1
75-26091	brown	50.0	1	9.0	1
75-26120	brown	50.0	1/0	12.0	1
75-26150	brown	50.0	2/0	15.0	1



### 1X7 WIRE LEADER

WITH LOOP AND TREBLE

Very affordable steel wire with loop and strong treble.

Art.-No.	Color	Rig Length cm	Treble Size	Strength kg	Content pc.
75-27090	brown	50.0	4	9.0	1
75-27091	brown	50.0	2	9.0	1
75-27120	brown	50.0	1	12.0	1
75-27121	brown	50.0	1/0	12.0	1

## PREDATOR LEADERS



### Titanium Leaders „Single Strand“

When a normal wire leader does not satisfy your demands, lacks the necessary flexibility or gets kinks too fast, when it features less linear strength than desired or simply is not slim enough, you should try the „Single Strand“ titanium predator leaders. We promise a wonderful fishing experience and a safe fight with the fish.

- High linear strength compared to its diameter
- Optimal stiffness – perfect for fishing with jerkbaits or trolling
- Slim diameter



## 1X1 TITANIUM LEADER

WITH SWIVEL AND SNAP

Equipped with swivel and Corlock snap with wide curve for optimal lure action.



Art.-No.	Rig Length cm	Strength kg	Content pc.
75-84308	20.0	8.0	2
75-84312	20.0	12.0	2
75-84318	20.0	18.0	1
75-84408	30.0	8.0	2
75-84412	30.0	12.0	2
75-84418	30.0	18.0	1

### CORLOCK KARABINER

Our titanium, 7x7 and 1x19 leaders are all together equipped with the Corlock snaps.

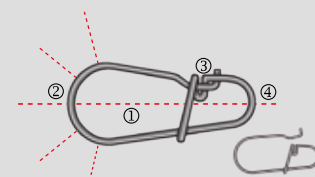

1. Symmetric design for a perfect balance
2. The extra-wide curve cares for an optimal lure action. Fitting for all lures
3. Super strong and reliable lock. Easy to operate
4. Narrow curve to the swivel, leader loop knot or main line to keep the knot in a centered position



### 7x7 Wire Leaders

49 single steel strands are braided to an especially soft and flexible leader material, which is excelled by a very high linear strength. Especially small lures as mini plugs, spinners, spoons or jigs benefit from this extremely flexible steel wire.

- blue: 6kg
- green: 9kg
- red: 13kg

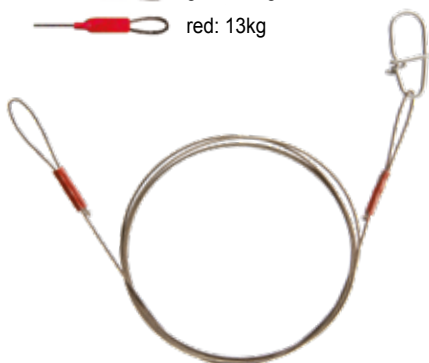

## 7X7 WIRE LEADER

WITH SWIVEL AND SNAP

Equipped with swivel and the Corlock snap. The perfect leader for spin fishing. The wide curve cares for an optimal lure action.

Art.-No.	Color	Rig Length cm	Strength kg	Content pc.
75-43060	brown	20.0	6.0	2
75-43090	brown	20.0	9.0	2
75-43130	brown	20.0	13.0	2
75-44060	brown	30.0	6.0	2
75-44090	brown	30.0	9.0	2
75-44130	brown	30.0	13.0	2
75-45060	brown	45.0	6.0	2
75-45090	brown	45.0	9.0	2
75-45130	brown	45.0	13.0	2

## 7X7 WIRE LEADER

WITH LOOP AND SNAP

With loop and Corlock snap.

Art.-No.	Color	Rig Length cm	Strength kg	Content pc.
75-41060	brown	60.0	6.0	2
75-41090	brown	60.0	9.0	2
75-41130	brown	60.0	13.0	2

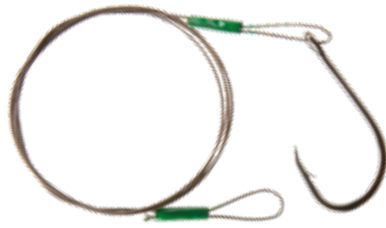

### 7X7 WIRE LEADER

WITH LOOP AND SINGLE HOOK

With loop and single hook.

Art.-No.	Color	Rig Length cm	Hook Size	Strength kg	Content pc.
75-46060	brown	50.0	1	6.0	1
75-46090	brown	50.0	1/0	9.0	1
75-46130	brown	50.0	2/0	13.0	1



### 7X7 WIRE LEADER

WITH LOOP AND TREBLE

With loop and one treble hook.

Art.-No.	Color	Rig Length cm	Treble Size	Strength kg	Content pc.
75-47060	brown	50.0	4	6.0	1
75-47090	brown	50.0	2	9.0	1
75-47091	brown	50.0	1	9.0	1
75-47130	brown	50.0	1/0	13.0	1



### 1x19 Wire Leaders

Especially developed for fishing for zander and pike. Very flexible and with reduced scaring effect thanks to the inconspicuous brown color.



### 1X19 ASSIST HOOK

WITH TREBLE HOOK

Indispensable assist hook for fishing with soft plastic lures. Optimal combination of length, diameter and hook size and equipped with one strong CGS treble. These assist hooks do not impair the lure action at all but increase the hooking rate dramatically.

Art.-No.	Color	Rig Length cm	Treble Size	Strength kg	Recommended Lure Length cm	Content pc.
75-37090	brown	5.0	6	9.0	8-10	2
75-37120	brown	8.0	4	12.0	10-14	2
75-37121	brown	9.0	4	12.0	14-16	2
75-37160	brown	10.5	2	16.0	16-20	2
75-37161	brown	12.0	2	16.0	18-22	2

- blue: 6kg
- green: 9kg
- red: 12kg
- yellow: 16kg



### 1X19 WIRE LEADER

WITH SWIVEL AND SNAP

1x19 wire leader with swivel and Corlock snap.

Art.-No.	Color	Rig Length cm	Strength kg	Content pc.
75-34060	brown	30.0	6.0	2
75-34090	brown	30.0	9.0	2
75-34120	brown	30.0	12.0	2
75-34160	brown	30.0	16.0	2
75-35060	brown	60.0	6.0	2
75-35090	brown	60.0	9.0	2
75-35120	brown	60.0	12.0	2
75-35160	brown	60.0	16.0	2

## FISHING LEADS



### SPLIT SHOT ASSORTMENT

SMALL BOX | FINE SORTING

Small and handy round box with fine split shots (0.10g-0.64g) in 6 compartments.

Art.-No.	Weights g	Content Set g
81-40070	0.10-0.64	70



### SPLIT SHOT ASSORTMENT

LARGE BOX | FINE SORTING

Large round box with fine split shots (0.10g-0.64g) in 6 compartments.

Art.-No.	Weights g	Content Set g
81-40120	0.10-0.64	120



### SPLIT SHOT ASSORTMENT

LARGE BOX | COARSE SORTING

Large round box with coarse split shots (0.64g-1.80g) in 6 compartments.

Art.-No.	Weights g	Content Set g
81-41120	0.64-1.80	120



### DEPTH FINDER SET

COMPACT FORM

Art.-No.	Weights g	Content Set pc.
81-47002	10/15/20	3



### DEPTH FINDER SET

SLIM FORM

Art.-No.	Weights g	Content Set pc.
81-47001	5/10/15	3

### TIROLER HÖLZL

„Tiroler Hölzl“ - essential for fishing in currents and fencefull waters.



### PEAR LEAD

Classic pear shape lead with swivel.



Art.-No.	Weight g
08-06010	10.0
08-06015	15.0
08-06020	20.0
08-06025	25.0
08-06030	30.0
08-06040	40.0
08-06050	50.0
08-06060	60.0
08-06080	80.0
08-06100	100.0

Art.-No.	Weight g	Content pc.
81-29010	10.0	1
81-29020	20.0	1
81-29030	30.0	1
81-29035	35.0	1
81-29040	40.0	1
81-29050	50.0	1
81-29060	60.0	1
81-29070	70.0	1
81-29080	80.0	1
81-29100	100.0	1

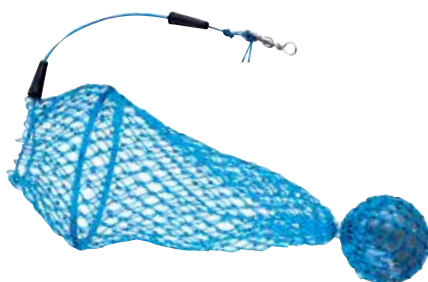

### EEL FEEDER

Special feeder with nylon net and lead to fill with pieces of fish and crushed worms.

Art.-No.	Length mm	Weight g	Content pc.
49-28040	90	40.0	1
49-28050	90	50.0	1
49-28060	90	60.0	1



**Fishing Equipment**



**CRIMPING PLIERS M|1201-3**

WITH SINGLE PRESSURE POINT

Very good crimping pliers with 5 pressure points, ideal for predator montages. Top quality.

Art.-No.	Length cm	Content pc.
84-12013	15.0	1



**CRIMPING PLIERS M|1010-0**

WITH 2 PRESSURE POINTS

Premium crimping pliers with precise pressure points, which fix the wire securely within the crimp.

Art.-No.	Length cm
84-10100	13.75



**PRO CARP BOILIE TOOL SET**

Very affordable complete set consisting of boilie driller and needle, splicing needle and stringer needle.

Art.-No.	Content Set pc.
11-04400	4



## BAIT NEEDLES

### BAIT NEEDLE M|1000-2

Bait needle made of stainless steel with movable eye.

Art.-No.	Length cm	Content pc.
83-10002	12.5	2

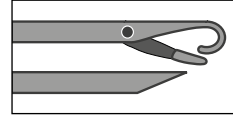

### BAIT NEEDLE M|1000-3

Classic bait needle made of stainless steel with permanent eye.

Art.-No.	Length cm	Content pc.
83-10003	17.0	2

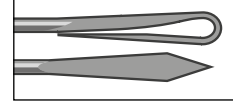

### BAIT NEEDLE M|1000-5

EXTRA-STRONG

Strong bait needle with movable eye.

Art.-No.	Length cm	Content pc.
83-10005	20.0	2

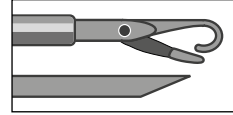

### WORM NEEDLE M|1000-1

Ideal worm needle for putting the worm on the hook.

Art.-No.	Length cm	Content pc.
83-10001	12.0	2

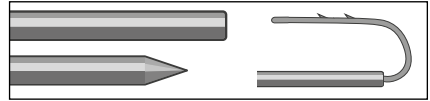

### LUGWORM NEEDLE M|1001-2

Special lugworm needle made of brass.

Art.-No.	Length cm	Content pc.
83-10012	25.0	2

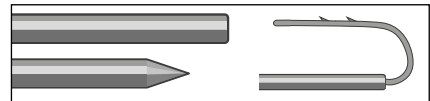

### LUGWORM NEEDLE M|1001-3

Lugworm needle in top quality made of stainless steel.

Art.-No.	Length cm	Content pc.
83-10013	32.0	2

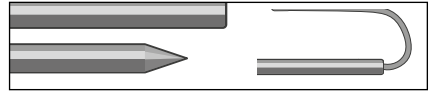

### PRIEST M|1400-2

Priest with heavy brass head and a practical knife blade and a descaler - that can be integrated into the priest for transportation.



Art.-No.	Length cm	Weight g	Content pc.
83-14002	19.5	210	1

**FISHING EQUIPMENT**



**SMOKING OVEN**

With this smoker up to 6 trouts can be smoked simultaneously on 2 trays. 2 large burning pots distribute the heat equally and constantly. The lid is sealed.

Art.-No.	Size cm	Content pc.
68-10000	42x26x13	1



**SMOKING OVEN**

XL-SIZE

3 large burning pots distribute the heat equally and constantly. The lid is sealed.

Art.-No.	Size	Size cm	Content pc.
68-10005	XL	50x26x12	1



**BIG FISH SCALE M|2600**

WEIGHING RANGE UP TO 100KG

Mechanical big fish scale in extremely stable design.

Art.-No.	Weighing Area (max.) kg	Content pc.
85-52600	100	1



**AERATION PUMP M|40006**

High-performance aeration pump with 2 speeds:

Speed "H"

- Pumping performance 1.0l/min
- Battery life: 25 hours

Speed "L"

- Pumping performance 0.8l/min
- Battery life: 48 hours



Battery type: 1x type „D“-1.5V (Battery not included in delivery)



Art.-No.	Content pc.
85-40006	1

## FISHING EQUIPMENT



### SPLITRING PLIERS M|1100-1

STRAIGHT

Compact and strong fishing pliers with split ring function – made of premium carbon steel. Easy to use thanks to the built-in blocking spring. Can be applied universally for cutting leaders and lines, detaching hooks and for crimping wire leaders.

Equipped with anti-slip handle.

Art.-No.	Length cm	Content pc.
84-11001	16.5	1



### UNHOOKING PLIERS M|1100-2

M-SIZE | CURVED

Very strong pliers with powerful, curved jaws made of premium carbon steel. Easy to use thanks to the built-in blocking spring. Can be applied universally for cutting leaders and lines, detaching hooks and for crimping wire leaders.

Equipped with anti-slip handle.

Art.-No.	Length cm	Size	Content pc.
84-11002	16.0	M	1



### UNHOOKING PLIERS M|1100-4

L-SIZE | CURVED

Slim and handy all-round fishing pliers for gentle unhooking – made of premium carbon steel. Can be applied universally for cutting leaders and lines, detaching hooks and for crimping wire leaders.

Equipped with anti-slip handle.

Art.-No.	Length cm	Size	Content pc.
84-11004	17.5	L	1



### HOOK REMOVER PLIERS M|1001

CURVED

Unhooking pliers made of stainless steel - excellent quality.

Art.-No.	Length cm	Content pc.
84-10016	16.0	1
84-10019	19.0	1



### FISHING SCISSORS M|1010-5

Perfectly made for braided and mono lines. Small and handy.

Art.-No.
84-10105



### HOOK REMOVER PLIERS M|1001

STRAIGHT

Unhooking pliers made of stainless steel - excellent quality.

Art.-No.	Length cm	Content pc.
84-10015	15.0	1
84-10018	18.0	1



### FILLETING KNIFE M|1300-7

Special, handy filleting knife with wide, flexible and sharp blade.

Equipped with ergonomic safety handle. Blade length: 16cm Total length: 28.5cm

Art.-No.	Length cm	Blade L. cm
82-13007	28.5	16.0



**FILLETING KNIFE M|1300-1**

Filleting set with very handy, compact filleting knife and sharpener.

Blade length: 15cm  
Total length: 28cm

Art.-No.	Length cm	Blade L. cm	Content pc.
82-13001	28.0	15.0	1



**FISHING KNIFE M|1300-2**

Very robust, sharp fishing knife.

Equipped with ergonomic anti-slip handle.  
Blade length: 10cm  
Total length: 21.5cm

Art.-No.	Length cm	Blade L. cm	Content pc.
82-13002	21.5	10.0	1



**FILLETING KNIFE M|1300-3**

Handy, sharp all-round filleting knife with flexible, slim blade.

Equipped with ergonomic anti-slip handle.  
Blade length: 20cm  
Total length: 31.5cm

Art.-No.	Length cm	Blade L. cm	Content pc.
82-13003	31.5	20.0	1



**KNIFE SET M|1300-8**

Fishing knife 1300-2, filleting knife 1300-3, filleting glove, sharpener and descaler in handy transportation box.

Art.-No.	Content Set pc.
82-13008	5

FISHING EQUIPMENT

FILLETING KNIFE M|1300-5



Handy, sharp all-round filleting knife with flexible, slim blade.

Equipped with ergonomic anti-slip handle.

Blade length: 16cm  
Total length: 27.5cm

Art.-No.	Length cm	Blade L. cm
82-13005	27.5	16.0

FISHING KNIFE M|1300-6



Handy sharp fishing knife with flexible, slim blade.

Equipped with ergonomic anti-slip handle.

Blade length: 9.5cm  
Total length: 21cm

Art.-No.	Length cm	Blade L. cm
82-13006	21.0	9.5



**CORMORAN®**

TEAM CORMORAN  
FILLETING KNIFE M|1224-0

Handy filleting knife with plastic knife sheath.

Art.-No.	Length cm	Blade L. cm
82-12240	28.0	15.0



**CORMORAN®**

TEAM CORMORAN  
FILLETING SET M|1100-0

De Luxe filleting set with filleting knife, sharpener and filleting glove in professional quality.

Art.-No.	Content Set pc.
82-11000	3





**Functions of right button**



High beam: maximum light output



Low beam: half light output



Flashing function



Permanent red light



Red light flashing

**Functions of left button**



Push left button 2x: headlamp is switched off



Automatic function activated



On/Off via swiping

**I-COR 1 HEADLAMP**

**DUST AND WATERPROOF (IPX4)**

The i-COR 1 headlamp is a variable lamp, every angler needs in many situations. At twilight or darkness, the i-COR 1 changes the night into day and you have everything under control.

The i-COR 1 is very robust, water-proof (IPX4 standard) and dust-proof lamp, with a fitting function for every kind of situation. For frequent use at the water, it is very lightweight and compact as well as comfortable to wear. It is operated via two buttons.

The i-COR 1 is equipped with a powerful (80 lumen) XPE LED and two red LEDs and an automatic function which can be controlled via swiping with the hand.

Battery type: 3x type AAA-LR03  
(Batteries not included in delivery)

Art.-No.	Content pc.
85-45201	1



High beam: maximum light output with 4 powered LEDs



Low beam: half light output with two powered LEDs



Permanent red light

**I-COR 3 HEADLAMP**

The i-COR 3 headlamp is very inexpensive but robust and features all functions, you need at fishing. Equipped with 4 white and 2 red LEDs, which enable a permanent red light.

The i-COR 3 is shaped ergonomically and very comfortable to wear.

Battery type: 3x type AAA-LR03  
(Batteries not included in delivery)



Battery type: 3x type AAA-LR03



Battery type: 3x type AAA-LR03

Art.-No.	Content pc.
85-45203	1



**DIGITAL SCALE M|5260-1**

**WEIGHING RANGE UP TO 25KG**

Small handy fish scale up to 25kg. You can chose between kg and lbs.

Disconnects automatically after 60 seconds.

Battery type: 1x type CR 2032  
(Battery not included in delivery)

Art.-No.	Weighing Area (max.) kg	Content pc.
85-52601	25	1

# BITE INDICATORS & ROD RESTS

## PRO CARP WIRELESS BITE INDICATOR F-8000 | 3+1

### COMPLETE SET | 3 BITE INDICATORS & RECEIVER

Wireless bite indicator with each adjustable sensitivity, volume and tone pitch.

The receiver is adjusted with the indicator settings both regarding sound and light. The tone pitch is automatically transmitted from the bite indicators while the volume of the receiver can be adjusted manually.

Drop backs and runs are as well displayed differently in sound and light via the power indicator and the LED bar, which also reflects the sensitivity setting.

With adjustable nightlight and mute function and furthermore completely sealed electronic components, making this bite indicators totally waterproof.

#### Technological features

##### Bite indicator

- Integrated wireless transmitter
- Sensitivity control
- Premium speakers
- Adjustable volume with integrated on-off switch
- Mute button switches volume to zero
- Adjustable tone pitch
- Combi LED light serves as power indicator and differently displays drop backs and runs with 20 sec. afterglow
- Combi LED light in red, blue and green
- LED bar as interval display (drop backs and runs are displayed differently), glowing in red
- Nightlight separately adjustable
- Soft touch finish
- Power out socket
- Separated battery compartment
- Connection for 9V monobloc battery

##### Receiver

- Displays up to 4 indicators
- On-off switch
- Adjustable volume
- Tone pitch is taken over from indicators
- Soft touch finish
- Separated battery compartment
- Connection for 2x AAA-1.5V batteries



**Pro Carp F-8000 Complete Set**  
3 bite indicators, 1 receiver and one matching receiver base are delivered in a practical suitcase. (Batteries not included in delivery)

Run



Drop back



The LED bar differently displays runs and drop backs (run: top down, drop back: bottom up) and reflects the previously adjusted sensitivity.



The volume can be switched off by the mute button. After 30 seconds it automatically is switched on again in the previous intensity.



The nightlight can be turned off and on manually



The 3 bite indicators of the set glow in red, blue and green



The nightlight glows in white



Adjustable volume with integrated on-off switch



Adjustable tone pitch – taken over by the receiver



Adjustable sensitivity control, displayed by the LED bar



Separate battery compartment for a 9V battery



Art.-No.	Color LED	Content Set pc.
11-80799	red/blue/green	3+1



## PRO CARP WIRELESS BITE INDICATOR F-4000

Professional wireless bite indicator complete set with adjustable sensitivity, volume and tone pitch. The receiver tone is matched with the indicator regarding both sound and light – the tone pitch is automatically transmitted from the bite indicators while the volume of the receiver can be adjusted manually. Drop backs and runs are displayed differently in sound and light via the power indicator LED and the LED bar, which also reflects the sensitivity setting. With adjustable nightlight function (integrated at the wheel) and mute function. Bite indicator and receiver can be switched on and off via push button. Thanks to the completely sealed electronics the bite indicator is perfectly water-protected.

### Technological features

#### Bite indicator

- Integrated transmitter
- Sensitivity control
- High-performance speakers
- Adjustable volume – can be reduced to zero
- Mute button shifts volume to zero
- Adjustable tone pitch
- On-off switch
- LED light serves as power indicator / 20 sec. afterglow
- LED light in red, blue, green and yellow, depending on set
- LED bar as bite interval display (drop backs and runs are displayed differently), glowing in red
- Nightlight separately adjustable
- Soft touch finish
- Power out socket
- Separated battery compartment
- Connection for 9V battery

#### Receiver

- Displays up to 4 indicators
- On-off switch
- Adjustable volume
- High-performance speakers
- Tone pitch is taken over from indicators
- Soft touch finish
- Separate battery compartment
- Connection for 3x AAA-1.5V batteries



Run



Drop back



The LED bar indicates runs and drop backs differently (run: top down, drop back: bottom up) and reflects the previously adjusted sensitivity.

(Batteries not included in delivery)

**S** Adjustable sensitivity control – displayed via the LED bar

**T** Adjustable tone pitch – taken over from receiver

Integrated nightlight



Power indicator with 20 sec. afterglow  
Run: constant light  
Drop back: flashing light

The volume can be switched off by the mute button. After 30 seconds it automatically is switched on again in the previous intensity.

**V** Adjustable volume

Press button 3 sec. – bite indicator turns on and off.

Press button 1 sec. – nightlight turns on and off.

Separate battery compartment for a 9V battery



## PRO CARP WIRELESS BITE INDICATOR F-4000 | 2+1

COMPLETE SET | 2 BITE INDICATORS & RECEIVER

Art.-No.	Content Set pc.
11-80450	2+1



## PRO CARP WIRELESS BITE INDICATOR F-4000 | 3+1

COMPLETE SET | 3 BITE INDICATORS & RECEIVER

Art.-No.	Content Set pc.
11-80451	3+1



## PRO CARP WIRELESS BITE INDICATOR F-4000 | 4+1

COMPLETE SET | 4 BITE INDICATORS & RECEIVER

Art.-No.	Content Set pc.
11-80452	4+1



## PRO CARP WIRELESS BITE INDICATOR F-2000

Super affordable wireless bite indicator complete set with adjustable sensitivity, volume and tone pitch. The receiver tone is matched with the indicator regarding both sound and light - the tone pitch is automatically transmitted from the bite indicators while the volume of the receiver can be adjusted manually. The combi LED light serves as bite indicator and power indicator. With 20 seconds afterglow and adjustable nightlight function at the wheel. Bite indicator and receiver can be switched on and off via push button. Thanks to the completely sealed electronics the bite indicator is perfectly water-protected.



### PRO CARP WIRELESS BITE INDICATOR F-2000 | 2+1

COMPLETE SET | 2 BITE INDICATORS & RECEIVER

Art.-No.	Content Set pc.
11-80360	2+1



### PRO CARP WIRELESS BITE INDICATOR F-2000 | 3+1

COMPLETE SET | 3 BITE INDICATORS & RECEIVER

Art.-No.	Content Set pc.
11-80361	3+1



### PRO CARP WIRELESS BITE INDICATOR F-2000 | 4+1

COMPLETE SET | 4 BITE INDICATORS & RECEIVER

Art.-No.	Content Set pc.
11-80362	4+1



#### Technological features

##### Bite indicator

- Integrated transmitter
- Sensitivity control
- High-performance speakers
- On-off switch
- Adjustable volume & can be reduced to zero
- Adjustable tone pitch
- Combi LED light serves as bite interval indicator and power indicator / 20 sec. afterglow
- Combi LED light in red, blue, green and yellow, depending on set
- Nightlight separately adjustable
- Soft touch finish
- Power out socket
- Separate battery compartment
- Connection for 9V battery

##### Receiver

- Displays up to 4 indicators
- On-off switch
- Adjustable volume
- High-performance speakers
- Tone pitch is taken over from indicators
- Soft touch finish
- Separate battery compartment
- Connection for 3x AAA-1.5V batteries

(Batteries not included in delivery)

**S** Adjustable sensitivity control

**T** Adjustable tone pitch – taken over from receiver

**9V** Separate battery compartment for a 9V battery



**V** Adjustable volume

Press button 3 sec. – bite indicator turns on and off.

Press button 1 sec. – nightlight turns on and off.

## PRO CARP BITE INDICATOR X-8000



### Technological features

#### Bite indicator

- Sensitivity control
- Premium speakers
- Adjustable volume with integrated on-off switch
- Adjustable tone pitch
- Combi LED light (4 colors adjustable via button) serves as bite interval indicator and power indicator / 20 sec. afterglow
- LED bar as interval display (drop backs and runs differently), glowing red
- Nightlight separately adjustable
- Soft touch finish
- Power out socket
- Separated battery compartment
- Connection for 9V battery

Art.-No.	Content pc.
11-80850	1

High-tech bite indicator with full equipment: adjustable sensitivity, volume and tone pitch. Drop backs and runs are displayed differently in sound and light via the power indicator (changeable color via button) and a LED bar, which also reflects the sensitivity setting. With adjustable nightlight function. Thanks to the completely sealed electronics the bite indicator is perfectly water-protected.



## PRO CARP BITE INDICATOR X-5000

Professional bite indicator with top equipment: adjustable sensitivity, volume and tone pitch. Drop backs and runs are displayed differently in sound and light via the LED bar, which also reflects the sensitivity setting. With adjustable nightlight function (integrated at the wheel) and mute function. Thanks to the completely sealed electronics the bite indicator is perfectly water-protected.



### Technological features

#### Bite indicator

- Sensitivity control
- High-performance speakers
- Adjustable volume, can be turned to zero
- Adjustable tone pitch
- On-off switch
- LED light serves as power indicator / 20 sec. afterglow
- LED bar serves as bite interval indicator (displays drop backs and runs differently), glowing red
- Nightlight can be switched on/off separately
- Mute button turns volume to zero
- High-performance speakers
- Soft touch finish
- Power out socket
- Separate battery compartment
- Connection for 9V battery

Art.-No.	Content pc.
11-80111	1



# BITE INDICATORS & ROD RESTS

## PRO CARP BITE INDICATOR X-2000

Affordable bite indicator with full equipment like sensitivity control, adjustable volume and tone pitch and a separate On-/Off push button. With adjustable nightlight function (integrated at the wheel) and completely sealed electronics. Thus the bite detector is perfectly water-protected.

(Battery not included in delivery)



### Technological features

#### Bite indicator

- Sensitivity control
- High performance speakers
- Adjustable volume – can be reduced to zero
- Adjustable tone pitch
- On-off switch
- Combi LED light serves as bite interval indicator and power indicator / 20 sec. afterglow
- Nightlight separately adjustable
- Soft touch finish
- Power out socket
- Separate battery compartment
- Connection for 9V battery

Art.-No.
11-80101

## PRO CARP BITE INDICATOR X-4000



Ambitious bite indicator with practical rotary knobs at a great price. Thanks to the completely sealed electronics the bite indicator is perfectly water-protected.

### Technological features

#### Bite indicator

- Premium speakers
- Adjustable volume with integrated on-off switch
- Volume can be reduced to zero
- Adjustable tone pitch
- LED light serves as bite interval indicator and power indicator / 20 sec. afterglow
- LED light glows blue
- Soft touch finish
- Sounderbox connection
- Separated battery compartment
- Connection for 9V monobloc battery

(Battery not included in delivery)



## PRO CARP FLEXI-BUTT GRIP M|1107

WITH FLEXIBLE JAWS

The Pro Carp Flexi-Butt-Grip prevents a removing or shifting of the carp rod. Thanks to the implemented spring system, the flexible jaws with rubber inserts always have enough tension.



Art.-No.	Color LED	Content pc.
11-80700	blue	1

Art.-No.	Content pc.
11-07038	1

**BANKSTICKS**

**BANKSTICK M|6358**

2-SECTIONED

Light telescopic bankstick with English thread for all common bite indicators or rod rests.

Art.-No.	Length cm	Sect.	Content pc.
63-58001	47-78	2	1
63-58002	78-130	2	1

**BANKSTICK M|6359**

2-SECTIONED | WITH THREADED TIP

Light telescopic bankstick with English thread for all common bite detectors or rod rests. Equipped with threaded tip, which can be screwed into the ground easily.

Art.-No.	Length cm	Sect.	Content pc.
63-59001	55-95	2	1
63-59002	80-135	2	1

**BANKSTICK M|6360**

2-SECTIONED | WITH QUICK LOCK

Light bankstick with quick lock and English thread for all common bite indicators or rod rests.

Art.-No.	Length cm	Sect.	Content pc.
63-60001	50	2	1

**BANKSTICK M|6361**

2-SECTIONED | WITH QUICK LOCK AND THREADED TIP

Light bankstick with quick lock and English thread for all common bite indicators or rod rests. Equipped with threaded tip, which can be screwed in the ground easily. The telescopic inner section is equipped with a spike and thus can be used as single-piece bankstick.

Art.-No.	Length cm	Sect.	Content pc.
63-61001	30	2	1
63-61002	45	2	1
63-61003	60	2	1

The telescopic inner section of M|6360 and M|6361 is equipped with a spike and thus can be used as single-piece bankstick.



63-58 ...

63-60001

63-59 ...

63-61 ...

**3-REST ROD POD M|81004**

FOR 3 RODS | VARIABLY ADJUSTABLE

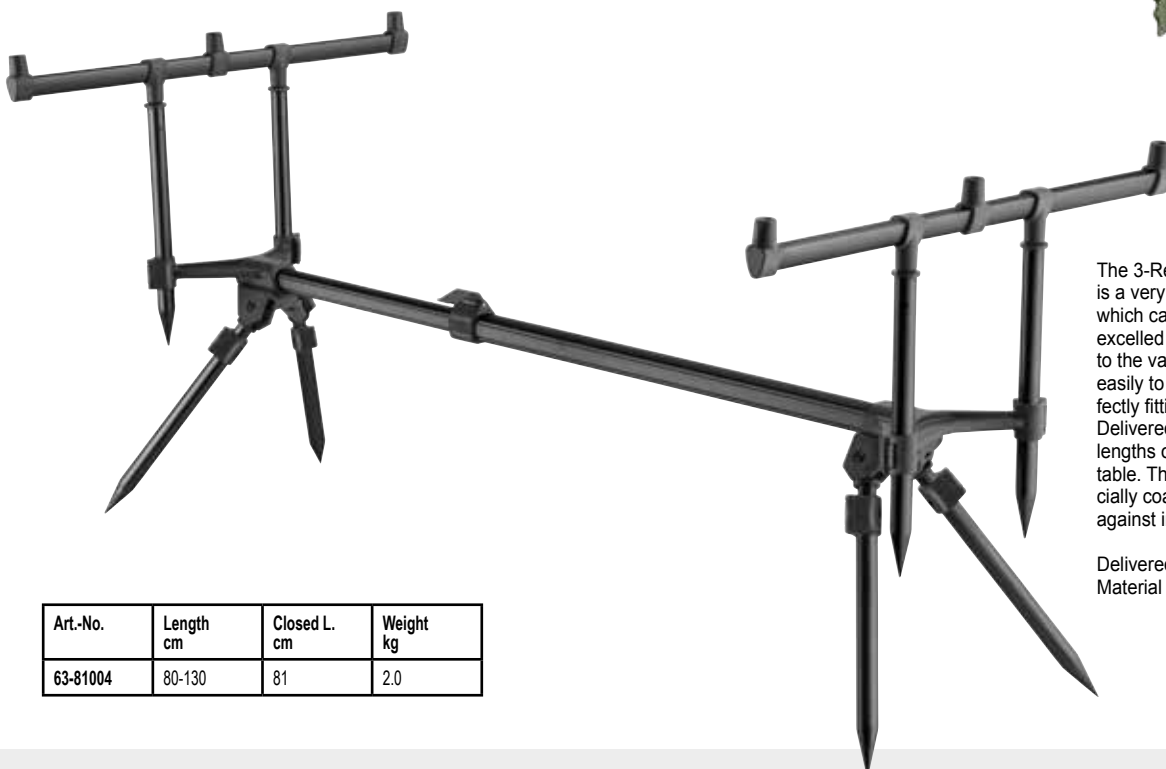

Art.-No.	Length cm	Closed L. cm	Weight kg
63-81004	80-130	81	2.0

The 3-Rest Rod Pod model 81004 is a very lightweight and solid pod, which can be installed quickly and is excelled by its high toughness. Due to the variable legs and feet, it adapts easily to different ground and is perfectly fitting all rod lengths. Delivered with 3 rod rests – the lengths of the buzzer bars are adjustable. The aluminum bars are specially coated and extremely resistant against impacts and shocks.

Delivered with transportation bag. Material transportation bag: polyester

## PRO CARP GUN POD M|81001

FOR 3 CARP RODS | SLOPE ADJUSTABLE

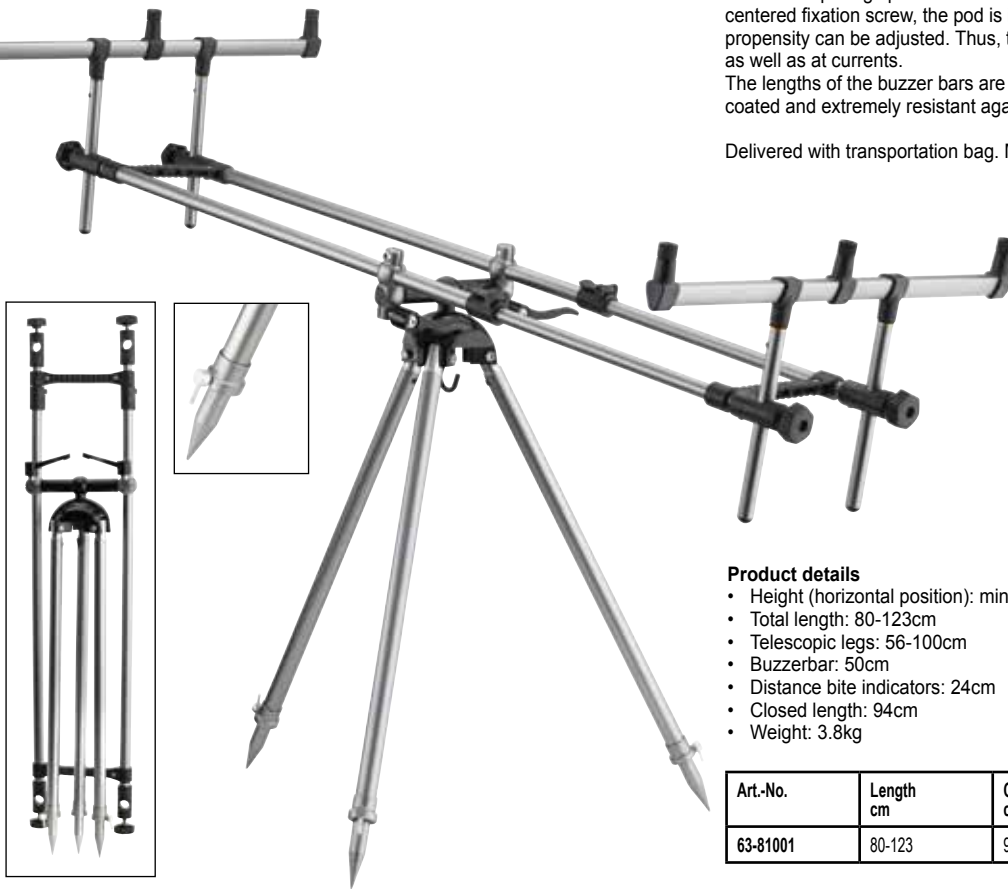

The sophisticated Pro Carp Gun Pod is designed for the use of 3 rods. The telescopic legs provide a safe base also on uneven ground. Thanks to the centered fixation screw, the pod is installed extremely fast and solid and the propensity can be adjusted. Thus, this pod is both suited for carp fishing at lakes as well as at currents. The lengths of the buzzer bars are adjustable. The aluminum bars are specially coated and extremely resistant against impacts and shocks.

Delivered with transportation bag. Material transportation bag: polyester

### Product details

- Height (horizontal position): min. 71cm – max. 123cm
- Total length: 80-123cm
- Telescopic legs: 56-100cm
- Buzzerbar: 50cm
- Distance bite indicators: 24cm
- Closed length: 94cm
- Weight: 3.8kg

Art.-No.	Length cm	Closed L. cm	Height cm	Weight kg
63-81001	80-123	94	71-123	3.8

## GUN POD M|81002

FOR 3 RODS | 360° ROTATABLE | SLOPE ADJUSTABLE

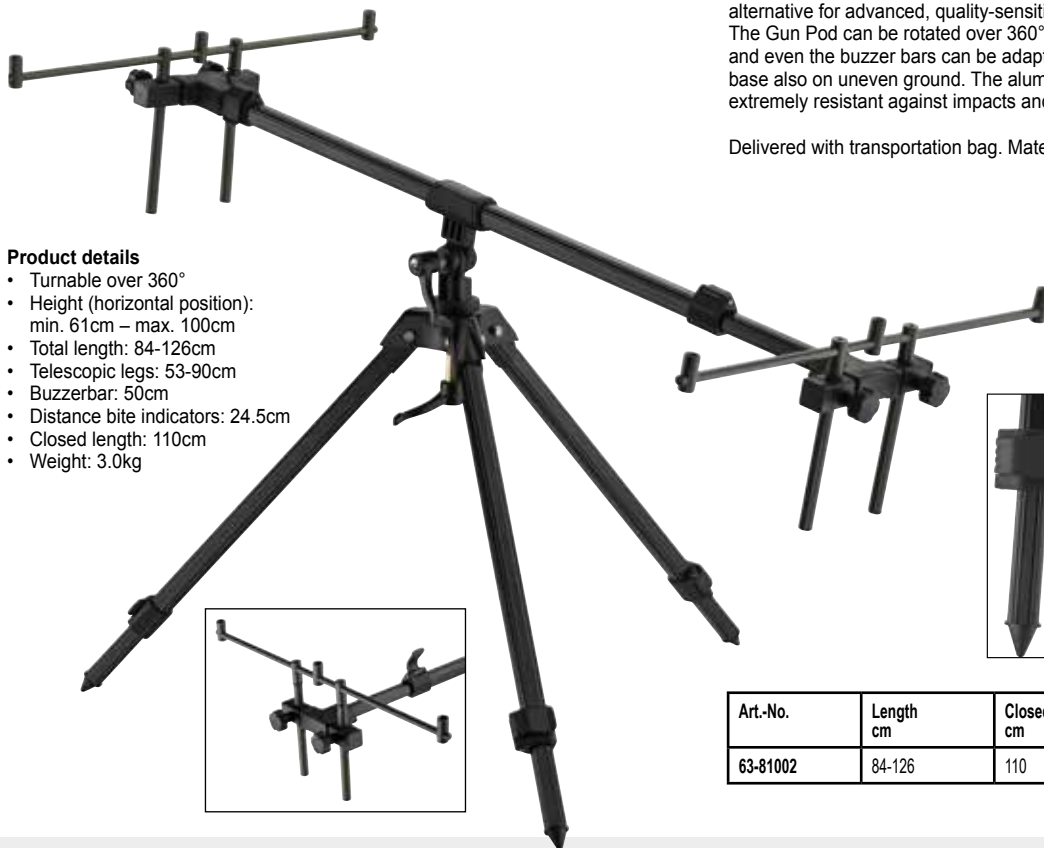

### Product details

- Turnable over 360°
- Height (horizontal position): min. 61cm – max. 100cm
- Total length: 84-126cm
- Telescopic legs: 53-90cm
- Buzzerbar: 50cm
- Distance bite indicators: 24.5cm
- Closed length: 110cm
- Weight: 3.0kg

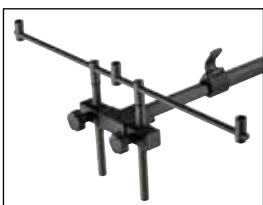

The Gun Pod model 81002 with 3 rod rests is more than a beginner's version for price-sensitive carp anglers – due to its design, quality and equipment, it is a real alternative for advanced, quality-sensitive anglers.

The Gun Pod can be rotated over 360°, the slope and the length are adjustable and even the buzzer bars can be adapted. The telescopic legs provide a safe base also on uneven ground. The aluminum bars are specially coated and extremely resistant against impacts and shocks.

Delivered with transportation bag. Material transportation bag: polyester

Art.-No.	Length cm	Closed L. cm	Height cm	Weight kg
63-81002	84-126	110	61-100	3.0

**ROD HOLDERS**

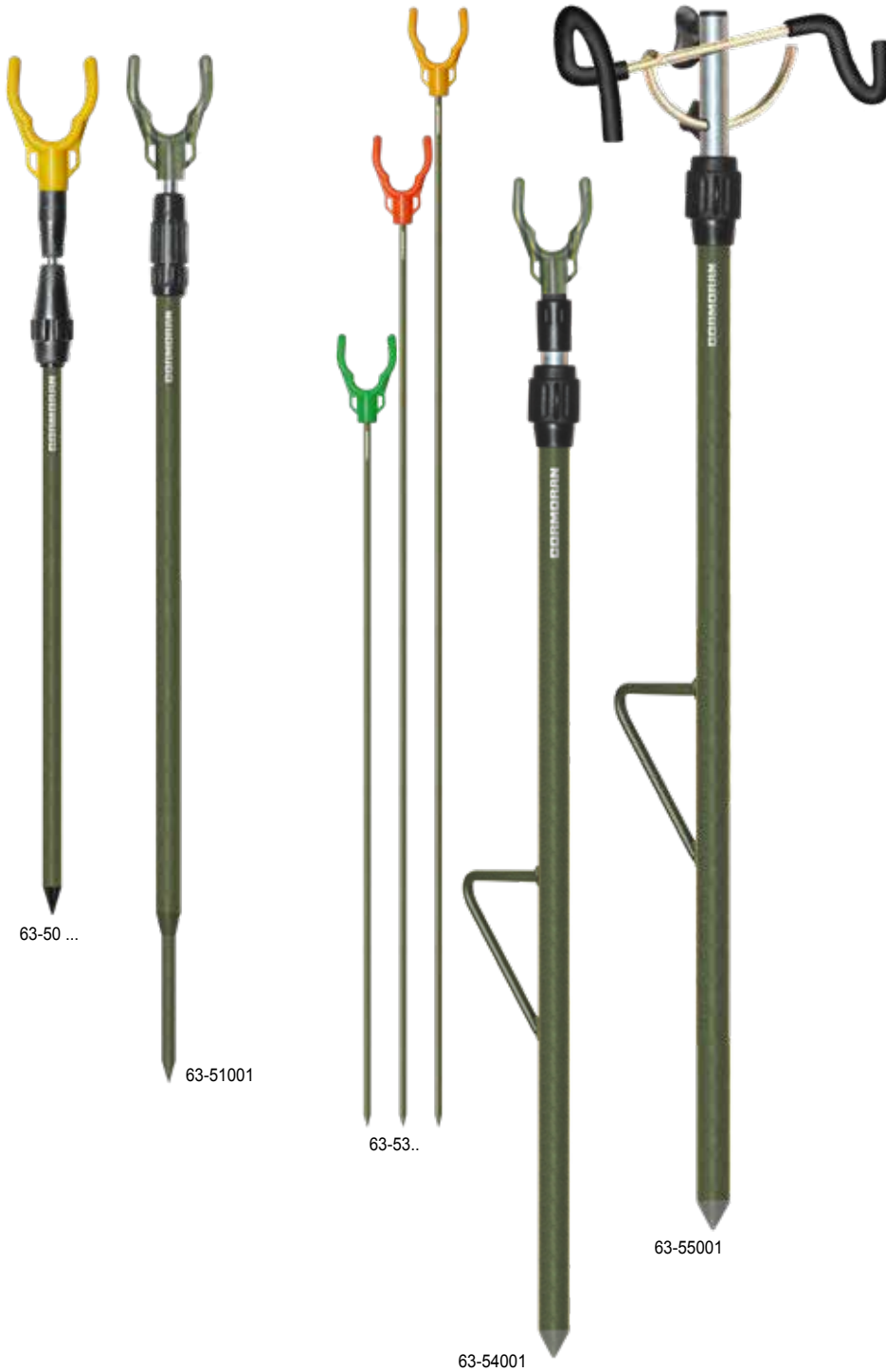

**ROD HOLDER M|6353**

1-SECTIONED

Super-affordable and solid rod holder with special rod rest.

Art.-No.	Length cm	Sect.	Content pc.
63-53001	60	1	1
63-53002	75	1	1
63-53003	85	1	1

**TELE ROD HOLDER M|6354**

2-SECTIONED | WITH SETUP SUPPORT

Extra-strong, easily adjustable rod holder with special rod rest and setup support. Very good for ground fishing at strong current.

Art.-No.	Length cm	Sect.	Content pc.
63-54001	80-135	2	1

**TELE ROD HOLDER M|6355**

2-SECTIONED | WITH SETUP SUPPORT

Extra-strong, easily adjustable rod holder with adjustable propensity. With setup support. Very good for ground fishing at strong current.

Art.-No.	Length cm	Sect.	Content pc.
63-55001	65-105	2	1

**TELE ROD HOLDER M|6350**

2-SECTIONED

Lightweight and easily adjustable rod holder with special rod rest.

Art.-No.	Length cm	Sect.	Content pc.
63-50001	34-46	2	1
63-50002	50-84	2	1
63-50003	75-130	2	1

**TELE ROD HOLDER M|6351**

2-SECTIONED | WITH STEEL TIP

Distortion-proof, easily adjustable rod holder with special rod rest and steel spike, which enters the ground easily.

Art.-No.	Length cm	Sect.	Content pc.
63-51001	55-100	2	1

ROD HOLDERS



78-20000

**BIG CAT CATFISH  
ROD HOLDER M|7820**

HEIGHT ADJUSTABLE |  
WITH TURNABLE ARM

Professional rod holder made of stainless steel - every bite indicator can be adjusted. The velcro fastener keeps the tight catfish rod stable and the turnable arm can be fixed with quick snap fasteners. The height of the rod holder is two times adjustable. Adjustable up to 155cm; transport length: 100cm

Art.-No.	Closed L. cm	Height cm	Content pc.
78-20000	100	-155	1

**TUBE ROD HOLDER M|10007**

Stageless adjustable rod holder with extreme robust bankstick.

Art.-No.	Length cm	Content pc.
63-10007	42	1



**TUBE ROD HOLDER M|6362**

WITH DOUBLE SCREW-IN SPEAR

Handy rod holder with EVA inlay (ø 30mm inside) and double screw-in spear for difficult grounds.

Art.-No.	Length cm	Ø inside cm	Content pc.
63-62001	41	3.0	1



**TUBE ROD HOLDER M|6363**

WITH ADJUSTABLE DOUBLE SPEAR

Handy rod holder with EVA inlay (ø 30mm inside) and steplessly adjustable double spear for difficult grounds.

Art.-No.	Length cm	Ø inside cm	Content pc.
63-63001	43	3.0	1

**TUBE ROD HOLDER M|10008**

Simple rod holder with strong bankstick for difficult soils.

Art.-No.	Length cm	Content pc.
63-10008	40	1





**BEACH POD X-TREME M|6310**

FOR 3 SURF RODS |  
WITH QUICK RELEASE FASTENER

This high-end tripod for 3 rods guarantees reliable stability and functionality even under rough weather conditions which delights even surf cast professionals. Thanks to its compact shape and its lightweight aluminum construction the transportation is very easy. The set-up is done fast and without problems. Thanks to quick snaps, the legs can be adjusted and secured easily. A hook is attached at the middle leg to be able to clip-in a sand bag for additional stabilization.

Art.-No.
63-10050

**BEACH POD M|6301**

FOR 2 SURF RODS |  
WITH QUICK RELEASE FASTENER

This tripod for 2 rods guarantees the highest stability even in rough conditions. Easy to transport as it is made from aluminium. The telescopic legs are adjustable up to 1.80m and are fixed easily and slip proof with quick snaps. In the point of this tripod a hook is attached to fix a sand bag for stabilization, if needed.

Art.-No.	Height cm
63-01777	-180

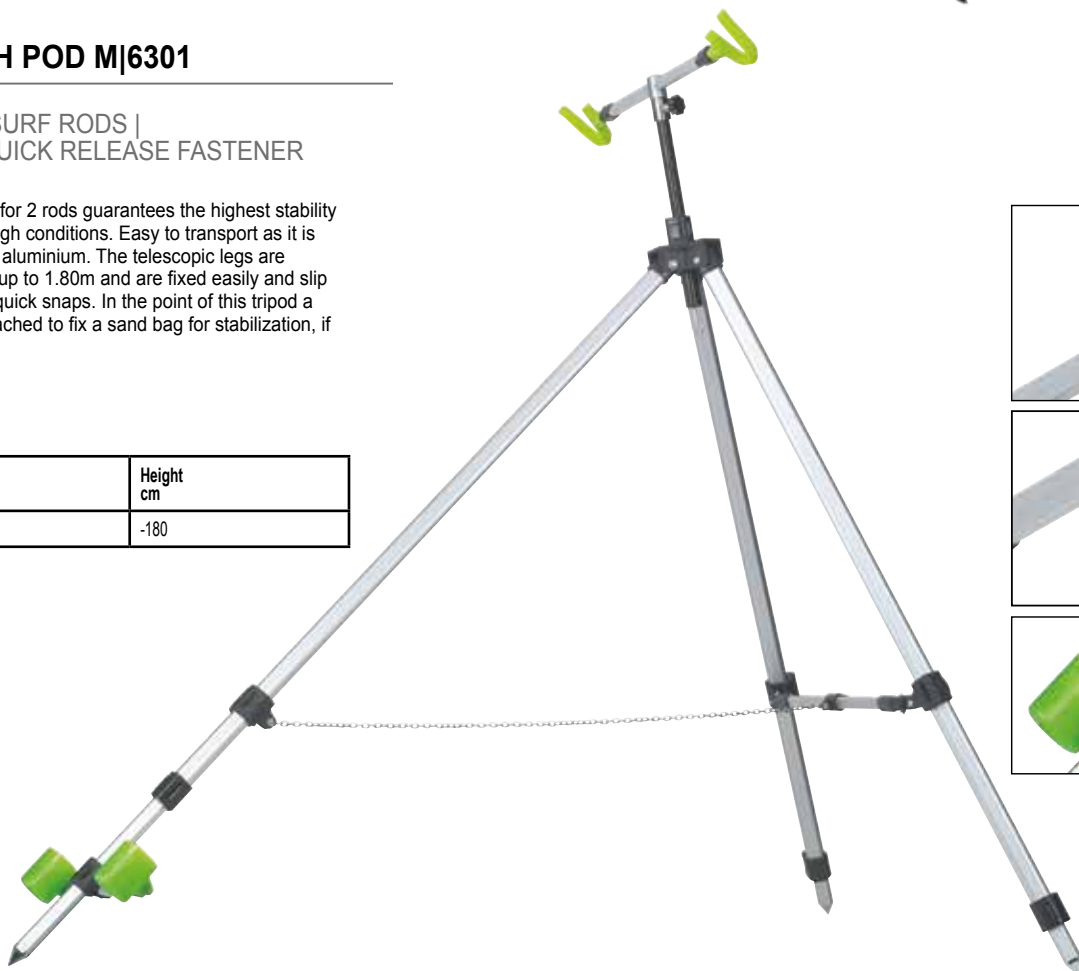

## FEEDER RESTS

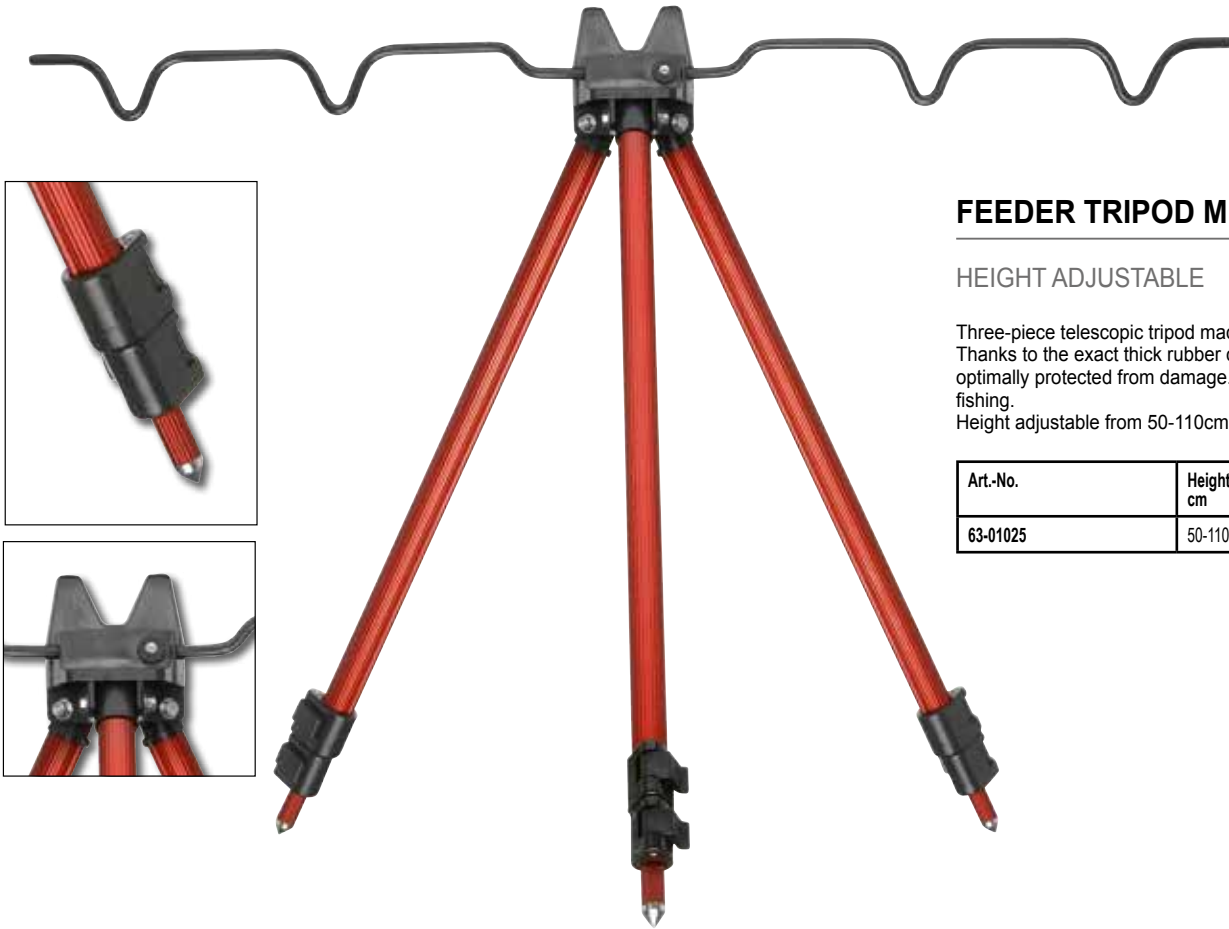

### FEEDER TRIPOD M|6301

HEIGHT ADJUSTABLE

Three-piece telescopic tripod made of aluminium. Thanks to the exact thick rubber coat, the rods are optimally protected from damage. Ideal for feeder fishing. Height adjustable from 50-110cm.

Art.-No.	Height cm
63-01025	50-110



### EVA FEEDER ROD REST M|6380-2

WITH 10 ROD POSITIONS

Art.-No.	Length cm	Content pc.
63-80102	24	1

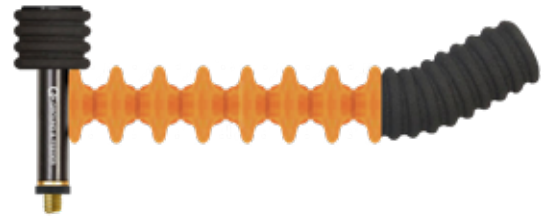

### SIDEWAY FEEDER ROD REST M|6380-3

WITH 6 ROD POSITIONS

Art.-No.	Length cm	Content pc.
63-80103	25	1



### LONGNOSE FEEDER ROD REST M|6367

Special rod rest for feeder fishing. Can be used as front or rear support.

Art.-No.	Length cm	Content pc.
63-67001	10.5	1

**WIRE KEEP NET M|6230**

By the special construction this keep net can stand firmly – ideal for herring fishing.

Art.-No.	Length cm	Ø cm
62-30805	40	34/28



**BAITFISH TRAP M|6109**

This small, handy fish trap is ideal for catching your bait fish. The bait fish trap is very stable and can be folded up small for transport.

Material: Net polyester

Art.-No.	Color Net	Size cm
61-09250	black	55x24x24



**BOAT KEEP NET M|6217**

Fish-friendly keep net with two floating bodies. Ideal for mounting on the boat.

Material: Net polyester

Art.-No.	Color Net	Length cm	Ø cm
62-17055	blue	55	35

**SHEET PILE WALL LANDING NET M|6221**

Round special landing net with aluminium frame and 5m rope. Perfect for landing fish from jetties etc.

Material: Net polyester

Art.-No.	Color Net	Mesh mm	Ø cm
62-21060	black	20x10	60

## LANDING NETS



### SEA TROUT NET M|6109

1-SECTIONED | FLOATING

Premium sea trout wading landing net with natural cork handle. The net's depth of 60cm prevents jumping out of the fish.

Material: Net polyester

Art.-No.	Size cm	Net Depth cm	Mesh mm	Sect.
61-09110	60x50	60	15x20	1



### WADING NET M|6253

1-SECTIONED | WITH QUICK LOCK

Premium wading landing net with light rubber-coated mesh (9mm) and magnetic quick release fastener at the handle.

Material: Net polyester, rubber coated

Art.-No.	Length cm	Size cm	Net Depth cm	Mesh mm	Sect.
62-531080	80	60x50	50	9	1

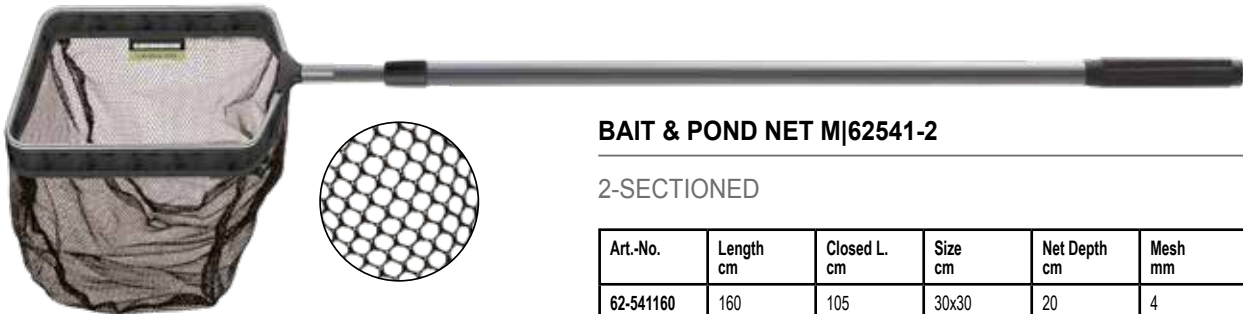

### BAIT & POND NET M|62541

Premium baitfish and pond net with robust plastic head and telescopic landing net handle with quick fastener for stepless and fast adjusting. Equipped with 4mm polyester net, which is integrated into the frame for long durability.

### BAIT & POND NET M|62541-2

2-SECTIONED

Art.-No.	Length cm	Closed L. cm	Size cm	Net Depth cm	Mesh mm	Sect.
62-541160	160	105	30x30	20	4	2

### BAIT & POND NET M|62541-3

3-SECTIONED

Art.-No.	Length cm	Closed L. cm	Size cm	Net Depth cm	Mesh mm	Sect.
62-541240	240	75	40x40	30	4	3

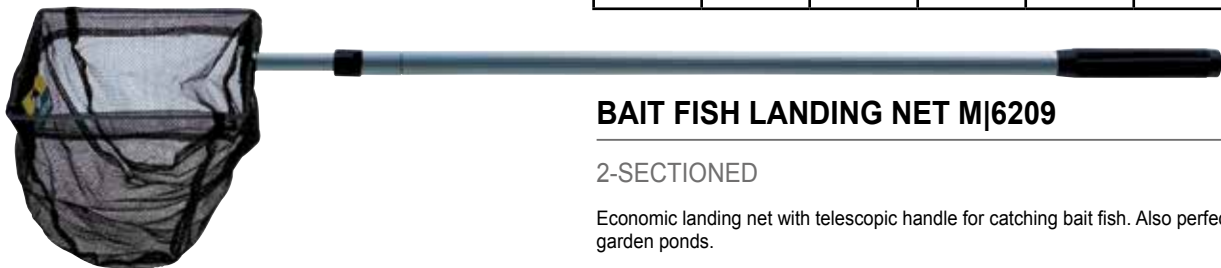

### BAIT FISH LANDING NET M|6209

2-SECTIONED

Economic landing net with telescopic handle for catching bait fish. Also perfect for garden ponds.

Material: Net polyester

Art.-No.	Length cm	Size cm	Mesh mm	Sect.
62-09155	155	25x18	3	2



**FOLDING NET  
„ULTRA-STRONG“ M|6247**

Ultra-strong foldable landing net with one-piece massive aluminum hinge and telescopic landing net handle, which can't twist during sliding. The length can be adjusted with the help of quick lock fasteners made of metal.

Equipped with non-smelling, rubberized net with 15x8mm mesh, while the bottom of the net is made of rubberized 6mm mesh.

Material: Net polyester, rubber coated

- Distortion-proof telescopic aluminum landing net handle
- Rubber handle
- One-piece aluminum landing net head, foldable
- Net frame: 10mm
- Rubberized polyester net, odor-free
- Mesh: 15x8mm, bottom 6mm

**FOLDING NET „ULTRA-STRONG“ M|6247-2**

2-SECTIONED

Art.-No.	Color Handle	Color Net	Length cm	Closed L. cm	Size cm	Net Depth cm	Mesh mm	Sect.
62-47222	gun smoke	green	220	95	60x60	55	15x8	2
62-47242	gun smoke	green	240	110	70x70	65	15x8	2



**FOLDING NET „ULTRA-STRONG“ M|6247-3**

3-SECTIONED

Art.-No.	Color Handle	Color Net	Length cm	Closed L. cm	Size cm	Net Depth cm	Mesh mm	Sect.
62-47243	gun smoke	green	240	70	60x60	55	15x8	3
62-47283	gun smoke	green	280	90	60x60	55	15x8	3
62-47313	gun smoke	green	310	105	70x70	65	15x8	3
62-47293	gun smoke	green	280	90	80x80	80	15x8	3
62-47323	gun smoke	green	310	105	80x80	80	15x8	3



Metal screw-caps

LANDING NETS



**FOLDING NET  
„STRONG“ M|6246**

Strong foldable landing net with one-piece massive aluminum hinge and „gun smoke“ anodized landing net handle, which can't twist during sliding. The length can be adjusted with the help of quick lock fasteners made of metal.

Equipped with non-smelling, rubberized net with 15x8mm mesh, while the bottom of the net is made of rubberized 6mm mesh.

Material: Net polyester, rubber coated

- Distortion-proof telescopic aluminum landing net handle
- Rubber handle
- One-piece aluminum landing net head, foldable
- 9mm frame
- Rubberized polyester net, odor-free
- Mesh: 15x8mm, bottom 6mm

**FOLDING NET „STRONG“ M|6246-2**

2-SECTIONED

Art.-No.	Color Handle	Color Net	Length cm	Closed L. cm	Size cm	Net Depth cm	Mesh mm	Sect.
62-46222	gun smoke	green	220	95	60x60	55	15x8	2

**FOLDING NET „STRONG“ M|6246-3**

3-SECTIONED

Art.-No.	Color Handle	Color Net	Length cm	Closed L. cm	Size cm	Net Depth cm	Mesh mm	Sect.
62-46223	gun smoke	green	260	75	60x60	55	15x8	3



Metal screw-caps



**FOLDING NET M|6242**

Affordable landing net with functional strong aluminum hinge and anodized telescopic landing net handles. This landing net is both light and strong enough to net also large specimen securely.

Equipped with non-smelling rubberized net with 10mm mesh.

Material: Net polyester, rubber coated

- Distortion-proof telescopic aluminum landing net handle
- Rubber handle
- Foldable aluminum landing net head
- 6mm metal frame
- Rubberized polyester net, odor-free
- Mesh: 10mm

**FOLDING NET M|6242-2**



2-SECTIONED

Art.-No.	Color Handle	Color Net	Length cm	Closed L. cm	Size cm	Net Depth cm	Mesh mm	Sect.
62-42122	red	green	120	50	40x40	28	10	2
62-42152	red	green	150	65	50x50	38	10	2
62-42192	red	green	190	85	50x50	38	10	2
62-42222	red	green	220	95	60x60	48	10	2



**FOLDING NET M|6242-3**

3-SECTIONED

Art.-No.	Color Handle	Color Net	Length cm	Closed L. cm	Size cm	Net Depth cm	Mesh mm	Sect.
62-42263	matt orange	green	260	75	60x60	48	10	3
62-42323	matt orange	green	320	105	60x60	48	10	3

## LANDING NETS



### FOLDING NET M|6245

Lightweight but very strong landing net with massive aluminum hinge and anodized telescopic landing net handle. The length can be adjusted with quick-lock fasteners, which are mounted on a milled thread.

Equipped with non-smelling rubberized net.

Material: Net polyester, rubber coated

- Rubber handle
- 9mm frame
- Rubberized polyester net, odor-free

### FOLDING NET M|6245-2

2-SECTIONED

Art.-No.	Color Handle	Color Net	Length cm	Closed L. cm	Size cm	Net Depth cm	Mesh mm	Sect.
62-45152	blue	green	150	65	50x50	40	15x8	2
62-45192	blue	green	190	85	50x50	50	15x8	2
62-45222	blue	green	220	95	60x60	55	15x8	2
62-45242	blue	green	240	110	70x70	65	15x8	2



### FOLDING NET M|6245-3

3-SECTIONED

Art.-No.	Color Handle	Color Net	Length cm	Closed L. cm	Size cm	Net Depth cm	Mesh mm	Sect.
62-45283	brown	green	280	90	60x60	55	15x8	3
62-45313	brown	green	310	105	70x70	65	15x8	3

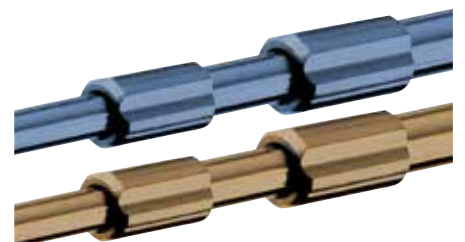

Metal screw-caps



**rubber coat**



**FOLDING NET „COMPACT“ M|6245-3**

3-SECTIONED

- Distortion-proof telescopic aluminum landing net handle (short sectioned)
- Rubber handle
- 9mm frame
- Rubberized polyester net, odor-free
- Mesh: 10mm

Material: Net polyester, rubber coated



Art.-No.	Color Handle	Color Net	Length cm	Closed L. cm	Size cm	Net Depth cm	Mesh mm	Sect.
62-45173	black	green	170	68	50x50	50	10	3
62-45213	black	green	210	75	60x60	50	10	3

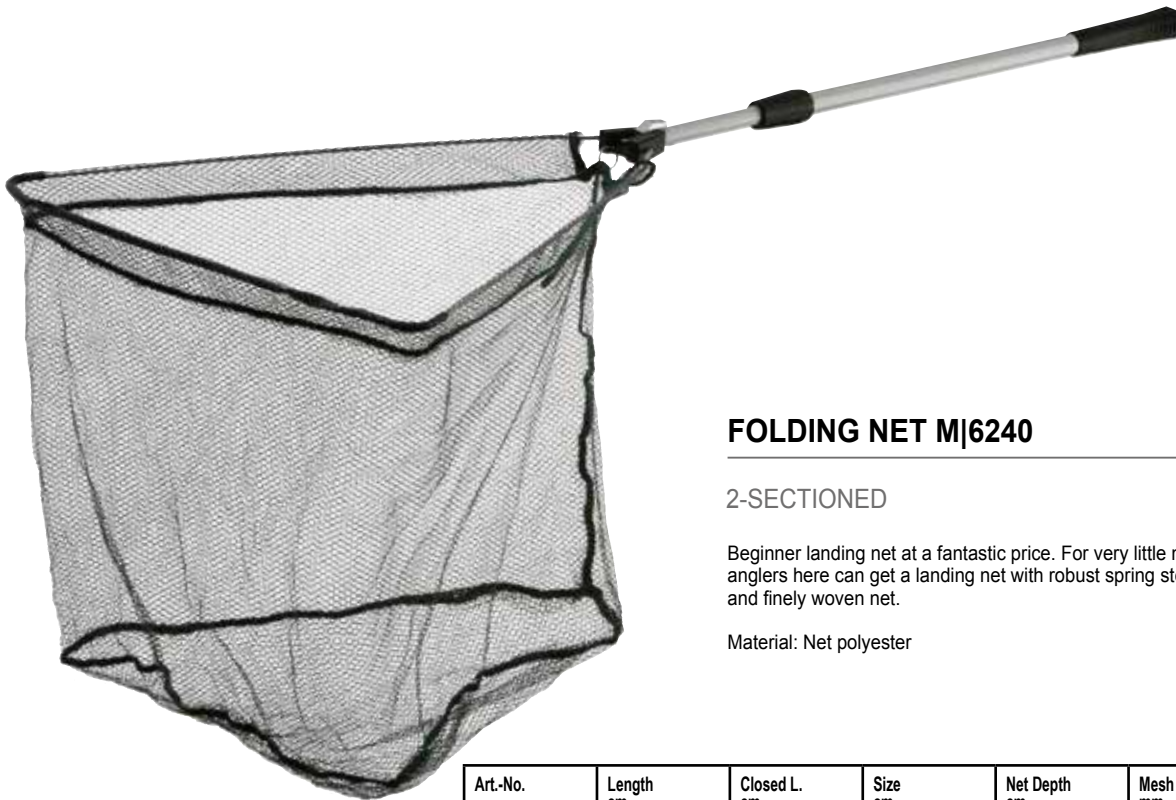

**FOLDING NET M|6240**

2-SECTIONED

Beginner landing net at a fantastic price. For very little money, anglers here can get a landing net with robust spring steel arms and finely woven net.

Material: Net polyester

Art.-No.	Length cm	Closed L. cm	Size cm	Net Depth cm	Mesh mm	Sect.
62-40122	120	50	40x40	28	5	2
62-40152	150	60	50x50	26	10	2
62-40182	180	70	60x60	48	10	2



**rubber coat**

**K-DON**  
CORMORAN



Strong foldable landing net head with metal hinge at the bail. Metal fixation screw.

**K-DON FOLDING BOAT NET M|6211**

2-SECTIONED | WITH FOLDABLE HEAD

Big predator landing net with practical, foldable head and a black anodized landing net handle, which can't twist during sliding in and out. With grey, rubberized net with meshes of 15x8mm, the net's bottom consists of rubberized 6mm meshes.

Material: Net polyester, rubber coated

Art.-No.	Color Handle	Color Net	Length cm	Closed L. cm	Size cm	Net Depth cm	Mesh mm	Sect.
62-11874	black	black	250	95	80x70	75	15x8	2



**LANDING NET HANDLE „SUPER“ M|6109**

3-SECTIONED

Telescopic landing net handle made of aluminium. Equipped with English thread.

Art.-No.	Length cm	Closed L. cm	Sect.
61-09330	330	120	3

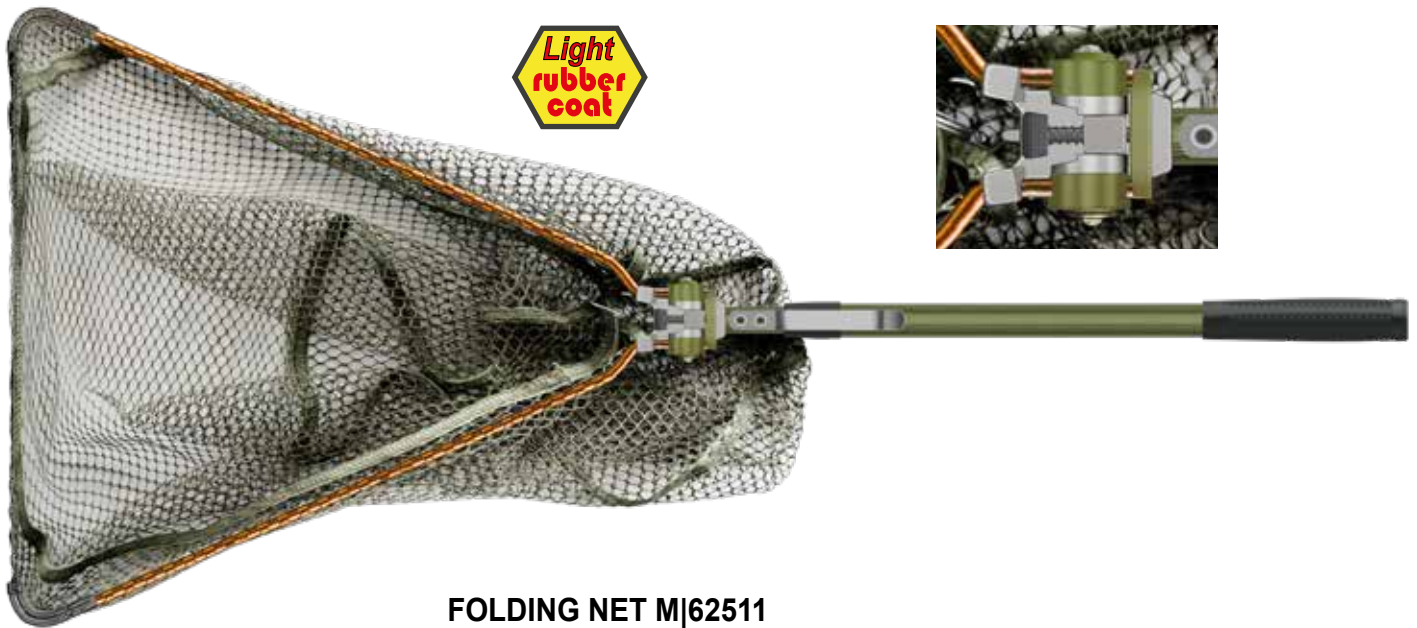

**FOLDING NET M|62511**

- Telescopic aluminum landing net handle with quick-fastener
- Rubber handle
- Foldable aluminum landing net head
- 8mm frame
- Spring steel belt buckle
- Rubberized polyester net, odor-free
- Mesh: 9mm

2-SECTIONED

Compact foldable landing net with light and robust aluminum joint, which is easy to use via sliding button. Equipped with telescopic landing net handle with quick fastener for a stepless and fast adjusting, spring steel belt buckle and smell-free, extra lightweight rubber-coated net (Light Rubber Coated) with 9mm mesh size.

Material: Net polyester, rubber coated

Art.-No.	Color Handle	Color Net	Length cm	Closed L. cm	Size cm	Net Depth cm	Mesh mm	Sect.
62-511130	olive green	green	130	53	45x45	30	9	2
62-511160	olive green	green	160	63	55x55	40	9	2



**TROUT FOLDING NET M|62512**

- One-piece aluminum landing net handle
- Rubber handle
- Foldable aluminum landing net head
- 8mm frame
- Spring steel belt buckle
- Rubberized, odor-free polyester net with fish-protecting middle section
- Mesh: 9mm

1-SECTIONED

Very lightweight landing net with light and robust aluminum joint, which is easy to use via sliding button. Equipped with 1-piece landing net handle, spring steel belt buckle and a combined net, made of smell-free, extra lightweight rubber-coated material (Light Rubber Coated) with 9mm mesh size and a fish-protecting middle section.

Material: Net polyester, rubber coated

Art.-No.	Color Handle	Color Net	Length cm	Closed L. cm	Size cm	Net Depth cm	Mesh mm	Sect.
62-512100	black	black/red	100	56	45x45	30	9	1



**TACKLE BOX M|10025**

M-SIZE | ONE-SIDED

Medium sized lure and tackle box. 4 long adjustable compartments which can be subdivided in 16 variable compartments.

Art.-No.	Size	Size cm
66-10025	M	28x18.5x4.5



**TACKLE BOX M|10026**

L-SIZE | ONE-SIDED

Big lure and all-round box. 1 big compartment and 5 long adjustable compartments, dividable into 20 compartments.

Art.-No.	Size	Size cm
66-10026	L	32x22.5x5



**TACKLE BOX M|10021**

DOUBLE-SIDED

Double sided accessory box with handle. 20 compartments which can be adjusted variably with 14 detachable dividers.

Art.-No.	Size cm
66-10021	30x21x7

**TACKLE BOX M|10023**

DOUBLE-SIDED

Lure and tackle box with 5 long compartments on the one side, and 8 compartments on the other.

Art.-No.	Size cm
66-10023	18x11x5



### TACKLE BOX M|10018

#### DOUBLE-SIDED

Double sided lure box. 6 long compartments in the lid, which can be subdivided into 16 smaller compartments. 4 medium compartments in the lower part, which can be subdivided too. 1 big compartment in the lower part, which can be divided into 4 sections.

Art.-No.	Size cm
66-10018	28x18x7



### TACKLE BOX M|10016

#### L-SIZE | SEPARABLE

Tackle box, which can be divided in two separate parts. Each with one handle. 10 adjustable compartments, which can be divided into 44 compartments. The perfect big sized lure box.

- **Big, double drawer tackle box for lures, divisible**
- **10 compartments, variably separable in up to 44 sections**
- **Dividers**

Art.-No.	Size	Size cm
66-10016	L	38x28x11



### TACKLE BOX M|10015

#### M-SIZE | SEPARABLE

Tackle box, which can be divided in two separate parts. Each with one handle. 10 adjustable compartments, which can be divided into 34 compartments. The perfect medium sized lure box.

- **Medium two-drawer box for lures, divisible**
- **10 compartments, variably separable in up to 34 sections**
- **Dividers**

Art.-No.	Size	Size cm
66-10015	M	28x22x6



### SMALL TACKLE BOX M|10035

For hooks, swivels, beads etc. With 10 separately closeable compartments and 2 adjustable compartments, which can be divided into 10 variable compartments.

Art.-No.	Size cm	Content pc.
66-10035	12x10.5x3.3	1



### BAIT BOX ASSORTMENT

Consisting of 3 boxes with lid (Ø 7cm, 9cm und 10cm).

- **3-pieces set of lure boxes with lid**

Art.-No.	Color	Ø cm	Content Set pc.
66-15020	green	7/9/10	3

## TACKLE BOXES - SERIES 11000

Good valued functional tackle boxes, which can be used for nearly all fishing techniques. Equipped with a robust handle and a functional quick release fastener.



### TACKLE BOX M|11001

M-SIZE | 2-TRAY

This good valued tackle box with 2 drawers contains 10 compartments of which 2 can be adjusted individually. With roomy bottom section for bigger equipment.

- 2-drawer tackle box
- 10 compartments, 2 variably separable
- Bottom section for larger supplies

Art.-No.	Size	Size cm
66-11001	M	30x18x14.5



### TACKLE BOX M|11004

L-SIZE | 3-TRAY

This good valued tackle box features 2 adjustable and one fixed drawers. The two adjustable ones can be divided into 8 big compartments. With roomy bottom section for bigger equipment.

- 3-drawer tackle box
- Upper drawer with 4 fixed sections
- The two lower drawers can be divided in up to 8 sections
- Bottom section for larger supplies

Art.-No.	Size	Size cm
66-11004	L	36x20x20



### LURE BOX M|1016

DOUBLE-SIDED

Double-sided lure box, which is especially suited for medium plugs up to 9.5cm. The plugs are ready to hand in 14 separated compartments to prevent the trebles from getting entangled. This box is also ideal for jigs, small balance jigs, mini-pilks etc.

- Two-sided lure box
- 14 separate sections
- Ideally suited for lures up to 9.5cm

Art.-No.	Size cm
66-11016	20x12.5x3.5



### LURE BOX M|1018

ONE-SIDED

Medium lure and accessories box with a big solid catch fastener, which is also easy to handle at twilight. Up to 15 adjustable compartments.

- Lure & supplies box with flap
- Compartments can be divided in up to 15 sections

Art.-No.	Size cm
66-11018	23x12.5x3.5

## TACKLE BOXES - SERIES 10000

High quality functional tackle boxes, which can be used for nearly all angling techniques. Robust construction, excellent processing and durable long-life materials. Equipped with a robust handle and a functional quick release fastener. All boxes of this series can be locked.



### TACKLE BOX M|10001

#### S-SIZE | 1-TRAY

Convenient tackle box with one drawer. Features 4 fixed and 3 adjustable compartments, which can be divided up to 6 compartments. With a roomy bottom section for bigger equipment.

- 1-drawer tackle box
- 7 compartments, 3 divisible in up to 6 sections
- Bottom section for larger supplies

Art.-No.	Size	Size cm
66-10001	S	34x20x15.5

### TACKLE BOX M|10002

#### M-SIZE | 2-TRAY

Compact tackle box with two drawers. Features 5 fixed and 9 adjustable compartments, which can be divided up to 19 compartments. With a roomy bottom section for bigger tackle.

- Compact, 2-drawer tackle box
- 14 compartments, 9 variably separable in up to 19 sections
- Bottom section for larger supplies

Art.-No.	Size	Size cm
66-10002	M	36x20x18.8



### TACKLE BOX M|10003

#### L-SIZE | 3-TRAY

Compact tackle box with 3 drawers. Features 20 fixed and 7 adjustable compartments, which can be divided up to 17 compartments. With a roomy bottom section for bigger equipment.

- Compact, 3-drawer tackle box
- 27 compartments, 7 variably separable in up to 17 sections
- Bottom for larger supplies

Art.-No.	Size	Size cm
66-10003	L	44x24x20

### TACKLE BOX M|10004

#### XL-SIZE | 3-TRAY

Extra large tackle box with 3 drawers. Features 20 fixed and 7 adjustable compartments, which can be divided up to 17 compartments. With a roomy bottom section for bigger equipment.

- 3-drawer tackle box
- 27 compartments, 7 variably separable in up to 17 sections
- Bottom section for larger supplies

Art.-No.	Size	Size cm
66-10004	XL	48x25x25

**LURE BAGS - SERIES 5000**

The compact, functional soft plastic lure bags with „Full Shock Protection“ represent the era of modern predator fishing and appear classical without being conservative. The orange ornamental elements give a vivid touch to the bags. These bags, which are delivered with the CORMORAN lure boxes, combine the claim of functionality with the desire for timeless design.



**LURE BAG M|5005**

**FULL SHOCK PROTECTED**

Perfect organization within the rucksack and a pleasant carrying comfort care for more fishing fun. The especially developed rucksack for soft plastic lures offers enough space for all necessary stuff. The adjustable, ventilated and thickly padded carrying straps ensure a comfortable carrying even when the rucksack is fully loaded. The 4 lure boxes (35.5x23x4.5cm) within the lower main compartment are accessible via a transparent net lip at the front, whereas the roomy upper main compartment can be opened nearly completely. Furthermore this rucksack is equipped with a big superimposed pocket with integrated compartments for small accessories and 2 roomy, padded side pockets. The superimposed hard case for glasses, which is easy to access and protects your glasses perfectly, is also a very handy gimmick. The PVC bottom ensures a great durability and can be cleaned easily.

Equipped with a broad, very comfortable and thickly padded carrying system. Size of bag: 40x2439cm (including superimposed pockets)

Material: Bag polyester, PVC coated

Art.-No.	Size cm
65-05005	40x24x39



**LURE BAG M|5002**

**FULL SHOCK PROTECTED**

Convenient to carry by hand or flicked over the shoulder! This handy, very compact soft plastic lure bag with “Full Shock Protection” is ideally suited to carry all necessary lures and stuff without being handicapped by too heavy weights during the “endurance sport” spin fishing. A smart choice for ambitious predator anglers. Delivered with 2 lure boxes (27x18.5x4cm) at the main compartment and a smaller lure and accessories box (20x14.5x4cm) at the superimposed pocket. The 2 superimposed, very spacious side pockets ensure a fast access to all essential tools or can store additional small tackle boxes. The pliers holders on both sides always keep this important tool ready to hand. The PVC bottom ensures a great durability and can be cleaned easily.

Equipped with carrying handle and an adjustable, padded shoulder strap. Size of bag: 40x15x21cm (including superimposed pockets)

Material: Bag polyester, PVC coated

Art.-No.	Size cm
65-05002	40x15x21



**LURE BAG M|5006**

**FULL SHOCK PROTECTED**

This outstanding frontloader soft plastic lure bag with “Full Shock Protection” and 2 separated main compartments, which are accessible via a shared lid, is a good choice for frequent anglers and for people with a sense for style. 4 lure boxes (35.5x23x4.5cm) are placed within the lower main compartment, the upper main compartment offers much space for many accessories. Both side pockets are also fully padded and thus perfectly protect the stored fishing stuff. The pliers holders on both sides always keep this important tool ready to hand.

Equipped with a durable PVC bottom and an economically shaped, adjustable shoulder strap with ventilated padding. Size of bag: 47x24x30cm (including superimposed pockets)

Material: Bag polyester, PVC coated

Art.-No.	Size cm
65-05006	47x24x30





Product delivered without content.



Delivered without pen.

### LICENCE BAG M|3041

High-end fishing license case with 4 transparent inside compartments and a pen holder for a secure storage of documents, day permits, fishing license etc.

Material: Bag polyester (600D), PVC coated



Art.-No.	Size cm
65-03041	14x20

### SNELLED HOOK BAG M|3025

Super practical, double-sided bag with clear bags for 20 packs of snelled hooks. Also swivels or steel wires can be stored neatly in this handy bag.

Material: Bag polyester (600D), PVC coated



Art.-No.	Size cm
65-03025	20x11.5



### RIG BAG M|3026

Universally usable rig & leader bag with 10 clear bags, which can be closed individually via zipper.

Material: Bag polyester (600D), PVC coated



Art.-No.	Size cm
65-03026	20x11.5



Equipping recommendation with CORMORAN tackle boxes

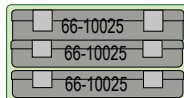

### SHOULDER BAG M|3031

One of the most frequently copied CORMORAN bags. Developed for spin and fly anglers. PVC coated at the inside, for an easy and quick cleaning, and equipped with a strong PVC bottom.

Equipped with 3 superimposed and 2 side pockets. Adjustable shoulder strap.

Material: Bag polyester (600D), PVC coated



Art.-No.	Size cm
65-03031	39x23x18



Equipping recommendation with CORMORAN tackle boxes

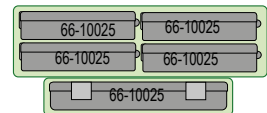

### SHOULDER BAG M|3032

Practical shoulder bag with one main compartment, one big superimposed pocket and adjustable shoulder strap. The main compartment is PVC coated and thus easy to clean.

Material: Bag polyester (600D), PVC coated



Art.-No.	Size cm
65-03032	36x30x17



**BELT BAG M|3029**

M-SIZE | 30L

This belt bag with an adjustable strap with quick snap has especially been made for spin anglers and offers enough space for any accessories and lures you need to keep handy. A big main compartment (23x12x8cm) and a superimposed pocket (19x11x4cm) for accessories or lure boxes, and additionally a pocket at the back (23x13x5cm) which offers space for a big lure box.

A slot pocket with zipper and 2 additional, movable pockets (14x15x5cm), which also can be used as belt bags separately, extend the stowage considerably.

Material: Bag polyester (600D), PVC coated

Equipping recommendation with CORMORAN tackle boxes

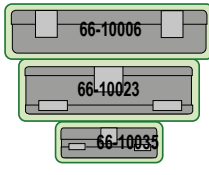

Art.-No.	Size cm
65-03029	23x13x17

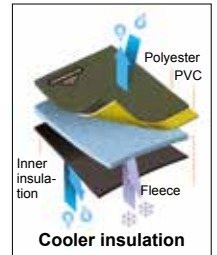

**ANGLER BACKPACK M|3038**

M-SIZE | 30L

Compact „De Luxe“ rucksack with a capacity of about 30 liters. We equipped this rucksack with an extremely comfortable carrying system and a padded, breathable back part, because primarily during spin fishing, you need to carry the rucksack over a long time.

Efficient and secure rod holders are located on each side, and a big zipper pocket is settled at the front. The lid is designed completely overlapping to improve splash water protection. Equipped with a solid PVC bottom.

Material: Bag polyester (600D), PVC coated

**ANGLER BACKPACK M|3039**

XL-SIZE | 40L

Extra big „De Luxe“ rucksack with a capacity of about 40 liters. Equipped with a 30-liters main compartment and a separated cooling compartment with integrated insulated fleece.

The extremely comfortable carrying system and the padded, breathable back part features this rucksack as well as both rod holders at each side and the big zipper pocket at the front. The lid is designed completely overlapping to improve splash water protection. Equipped with a solid PVC bottom.

Material: Bag polyester (600D), PVC coated



Art.-No.	Size	Size cm	Volume l
65-03038	M	35x45x20	30



Art.-No.	Size	Size cm
65-03039	XL	35x55x20

**ROD HOLDALLS**



**ROD BAG M|5121**

Very affordable rod bag with one main compartment, which can shelter up to 3 mounted rods easily. With long outer pocket for rod holder and umbrella, which can be opened widely via zipper and closed via a separate loop.

Equipped with a strong and reliable 10mm tent zipper. The adjustable shoulder strap and the solid handle are designed in a way that guarantees convenient transportation even when fully loaded.

Material: Bag polyester (600D), PVC coated

Art.-No.	Length cm	Capacity
65-12130	130	for 3 rods
65-12155	155	for 3 rods
65-12175	175	for 3 rods



**ROD BAG M|5122**

**FULL SHOCK PROTECTED**

Hardcase rod bag, which can shelter 2 mounted rods easily. Due to the hard shell, the rods are perfectly protected against shocks and damage during transportation. Of course also the reel compartment is thickly padded to offer optimal protection.

Equipped with a strong and very reliable tent zipper and a padded, adjustable shoulder strap.

Material: Bag polyester (600D), PVC coated

Art.-No.	Length cm	Capacity
65-12230	130	for 2 rods
65-12255	155	for 2 rods
65-12275	175	for 2 rods



**ROD BAG M|5123**

Very affordable rod bag for the transportation of numerous mounted and unmounted telescopic or detachable rods. The main compartment is separated via 2 flexible dividers to store the rods perfectly organized. With a long outer pocket for rod holder and umbrella, which can be opened widely via zipper and closed via separate loop.

Equipped with a strong and reliable 10mm tent zipper. The adjustable shoulder strap is designed in a way that guarantees convenient transportation even when fully loaded.

Material: Bag polyester (600D), PVC coated

Art.-No.	Length cm
65-12315	115
65-12330	130
65-12355	155
65-12375	175





**ROD BAG M|5124**

FULL SHOCK PROTECTED

Completely padded rod bag for one or two mounted rods. Due to the thick padding, the rod as well as the reel are perfectly protected against shocks or damages during transportation.

Equipped with a strong and reliable 10mm tent zipper and a solid handle.

Material: Bag polyester (600D), PVC coated

Art.-No.	Length cm	Capacity
65-12430	130	for 1-2 rods
65-12455	155	for 1-2 rods



**ROD BAG M|5091**

FULL SHOCK PROTECTED

High-end rod case with „Full Shock Protection“ lining. With 2 separated compartments, which can easily store up to 4 rigged rods. With a long outside pocket, which can be opened widely via zipper and closed via loop. The big outside pocket (35x22x6cm) with solid PVC bottom is also lined and thus perfectly protects the stored equipment.

With 2 adjustable and padded rucksack shoulder straps, a carrying handle and a solid PCV bottom.

Material: Bag polyester (600D), PVC coated

Art.-No.	Size cm	Capacity
65-09125	130x24x32	for 4 rods
65-09150	155x24x32	for 4 rods
65-09165	170x24x32	for 4 rods



**ROD BAG M|5092**

Very good valued holdall with 2 separated compartments, which can store up to 4 rigged rods easily. With a large outside pocket for rod seats etc., which can be opened widely via zipper and closed via loop.

Equipped with an adjustable shoulder strap and solid eyelets at the top and the bottom.

Material: Bag polyester (600D), PVC coated

Art.-No.	Length cm	Capacity
65-09220	125	for 4 rods
65-09240	145	for 4 rods
65-09265	170	for 4 rods



## ROD CASE M|5093

Classical rod case with 3 separated compartments for rigged rods. The long outside pocket, which can be opened via zipper over the whole length, stores umbrella or banksticks.

Equipped with 2 adjustable rucksack shoulder straps, a carrying handle and solid eyelets at the top and the bottom.

Material: Bag polyester (600D), PVC coated

Art.-No.	Length cm
65-09305	110
65-09325	130
65-09350	155
65-09370	175



## ROD SLEEVE M|5094

### FULL SHOCK PROTECTED

Perfectly protects rigged rods thanks to its thick „Full Shock Protection“ lining. Thus you are ready to fish without the necessity of rigging your rods previously.

Equipped with a solid PVC bottom, a solid carrying handle and eyelets at the top and the bottom. An additional reel or an unscrewable reel handle can be stored in the small, padded pocket at the inside.

Material: Bag polyester (600D), PVC coated



Art.-No.	Length cm	Capacity
65-09425	130	for 1 rod
65-09450	155	for 1 rod



## ROD TUBE BAG M|5096

### IMPACT-PROOF

The perfect protection for premium, rigged detachable rods. The solid, impact-proof plastic tube is lined with a fine nylon fabric at the inside and coated with 100% Polyester 600D at the outside. The integrated reel compartment is the highlight, thus you can store the completely rigged rod.

Equipped with an adjustable, thickly padded carrying handle.

Material: Bag polyester (600D), PVC coated; Inner lining nylon



Art.-No.	Length cm	Capacity
65-09650	155	for 1 rod



### ROD CASE M|5097

#### FULL SHOCK PROTECTED

Classical holdall with „Full Shock Protection“ lining and three separated compartments for rigged rods. The large superimposed pocket, which can be opened via zippers, offers enough space for an umbrella or banksticks.

Equipped with 2 adjustable rucksack shoulder straps, carrying handle and robust eyelets.

Material: Bag polyester (600D), PVC coated

Art.-No.	Length cm
65-09730	130
65-09755	155
65-09775	175
65-09795	195



### PRO CARP STALKER UNHOOKING MAT M|1112

Practical, compact Stalker unhooking mat with much comfort, which can be transported space-saving. Thanks to the PVC material it is cleaned fast and easily and it's very gentle for the sensitive mucosa of the carp.

Size: 100x60cm

Material: PVC

Art.-No.	Size cm
11-11201	100x60



**PRO CARP CARP BEDCHAIR M|8210**

6-LEGGED

Carp bed chair with lightweight aluminum frame and adjustable aluminum legs with mud feet. The lying surface is thick and comfortably padded.

Equipped with „Pro Carp Recliner“ rest quick snap and „Pro Carp Leg Adjustor“.

Material: Cover polyester (600D Oxford); Lining polyurethane

Art.-No.	Size cm
68-48210	210x78



**PRO CARP CARP BEDCHAIR M|8212**

6-LEGGED | WITH INTEGRATED PILLOW

Lightweight, compact and very comfortable. 6-leg carp bed chair with lightweight aluminum frame and adjustable aluminum legs with mud feet. The lying surface is thick and comfortably padded with an integrated pillow.

Equipped with „Pro Carp Recliner“ rest quick snap and „Pro Carp Leg Adjustor“.

Material: Cover polyester (600D Oxford); Lining polyurethane

Art.-No.	Size cm
68-48212	208x83



## PRO CARP CARP CHAIR M|7200

WITH ARMREST AND HIGH BACKREST

Very comfortable all-round carp chair with high backrest. With lightweight steel frame and adjustable aluminum legs with mud feet. Equipped with "Pro Carp Leg Adjustor" whereby you can adjust the sitting height quickly and exactly.

**Dimensions:**  
Seat: 50x50cm  
Back: 73cm  
Height: 30-41cm

Material: Cover polyester (600D Oxford)



Art.-No.	Size cm	Seat Height cm	Backrest Height cm
68-47200	50x50	30-41	73



## PRO CARP CARP CHAIR M|7300

WITH KIDNEY PROTECTION AND HIGH BACKREST

Luxury, high-end carp chair. Enormously comfortable. With integrated reno protector. With lightweight steel/aluminum frame and adjustable aluminum legs with mud feet. Equipped with "Pro Carp Recliner" rest quick snap and "Pro Carp Leg Adjustor", whereby you can adjust the sitting height quickly and exactly.

**Dimensions:**  
Seat: 52x45cm  
Back: 85cm  
Height: 43-54cm

Material: Cover polyester (600D Oxford)



Art.-No.	Size cm	Seat Height cm	Backrest Height cm
68-47300	52x45	43-54	85

## Detail explanations

### Polyester 600D

Tear-proof and abrasion-resistant material with water-proof PVC coating.

### Full Shock Protection

The shock absorbing fleece protects tackle boxes and accessories against damage due to impacts. Embedded between the outer polyester and the lining.

### Zippers

Reliable plastic spiral zipper of 7mm and CORMORAN pendants.

### PVC bottom

Ensures great durability, can be cleaned easily and additionally stabilizes the bag's bottom.

### Overlapping lid

Protects the main compartment from soaking water via the zipper as far as possible. For a fast opening and closing of the zipper simply turn the overlapping edging up and the complete zipper is uncovered.

### Pliers holder

Positioned at the bag's side for a quick access. Universal size for nearly all common pliers. Closable via hook and loop fastener.

### Shoulder strap

Within this series, all bags (except the rucksack) have a removable shoulder strap with padded, adjustable sholder pad.

### Design

Classical, conservative with ageless green. The orange ornamental elements give a vivid touch to the bags.

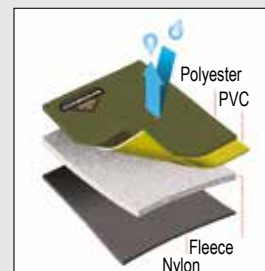

### Full Shock Protection

The shock absorbing fleece protects the equipment from getting damaged in case of hits and shocks. Embedded between polyester shell and nylon lining.





**FOLDING CHAIR M|9000**

Economic foldable chair with strong, tear proof covering.

Material: Cover polyamide

Art.-No.
68-90000



**ANGLER UMBRELLA M|3530**

XXL-SIZE | ARC MEASURE 350CM

Fishing umbrella with robust canopy. All seams are double stitched and gummed up with sealing tape, thus preventing the intrusion of water through the seams. Additionally this XXL umbrella features three eyelets, which enable fixation at windy conditions.

Delivered with tent pegs and guy wires.  
Arc measure: 300cm

Material: Umbrella cover nylon, water-repellent coated

Art.-No.	Color	Size	Size cm
68-35300	green	XXL	300



**UMBRELLA TENT M|3525**

WITH DETACHABLE BACKPLANE | ARC MEASURE 250CM

Umbrella with detachable backplane (via zipper). Equipped with tough metal umbrella ribs.

Delivered with tent pegs and guy wires.  
Arc measure: 250cm

Material: Umbrella cover polyester (210D), water-repellent coated

Art.-No.	Color	Size cm
68-35250	green	250

**Thermo Boots**

High quality, reliability, a good fit and a great look have been the standards for the development of these boots. The result are angler boots, which answer very high expectations. These boots are the first choice for spinning anglers, who move a lot during fishing. But this boots are also a convenient alternative to rubber boots for every other fisherman. They feature a strong inner shaft that stabilizes the foot and prevents snapping of the foot far better than a rubber boot or sneaker.



**ASTRO-THERMO BOOTS M|9177**

WITH NON-SLIP RUBBER SOLE

Very comfortable thermo laced shoe with rough cloddy non-slip rubber sole for particular sure-footedness. The sole construction is waterproof till the rubber belt. With strengthened high-cut toe cap for optimum mobility and protection of the toes. The thick foam padding contributes to optimum thermal comfort. Corrosion resistant smooth running shoe-eyes, strong quick-release hooks and the finger lug facilitate lacing these shoes.

Material: Outer material 80% velours leather, 20% nylon; Inner lining polyamide (Nylex); Sole thermoplastic rubber (TPR)

Art.-No.	Size
91-77040	39/40
91-77041	40/41
91-77243	42/43
91-77445	44/45
91-77546	45/46
91-77647	46/47

**Neoprene Socks & Gloves**



**NEOPRENE BOOT SOCKS M|9425**

HIGH CONSTRUCTION | ANTI-SLIP COATED

Neoprene socks with anti-slip sole.

Material: 90% neoprene, 10% nylon

Art.-No.	Color	Size
94-25001	green	38-41
94-25002	green	42-44
94-25003	green	45-47

**NEOPRENE GLOVES M|9410**

Thumb and fingers can be folded back.

Material: 90% neoprene, 10% nylon

Art.-No.	Color	Size
94-10002	dark green/black	M
94-10003	dark green/black	L
94-10004	dark green/black	XL

## NEOPRENE WADING CLOTHES

### NEOPRENE CHEST WADERS WITH RUBBER BOOTS

Made of 4mm double coated neoprene and breathable upper part. All seams are taped and 100% waterproof. Rubber boots with „Steel Shank“ sole are lined with neoprene.



### NEOPRENE CHEST WADERS M|9402

4MM NEOPRENE | WITH CLEATED HEEL AND FELT SOLE

Model 9402 with felt sole and cleated rubber heel



Art.-No.	Size
94-02041	40/41
94-02243	42/43
94-02445	44/45
94-02647	46/47

### NEOPRENE HIP WADERS M|9405

4MM NEOPRENE | WITH CLEATED SOLE

Made of 4mm double coated neoprene and breathable upper part. All seams are taped and 100% waterproof. Rubber boots with „Steel Shank“ sole are lined with neoprene.

Material trousers: 90% neoprene, 10% nylon

### NEOPRENE CHEST WADERS M|9403

4MM NEOPRENE | WITH CLEATED SOLE

Model 9403 with rubber sole

Sizes XL are special waist sizes.



Art.-No.	Size
94-03839	38/39
94-03041	40/41
94-03243	42/43
94-03243XL	42/43XL
94-03445	44/45
94-03445XL	44/45XL
94-03647	46/47
94-03647XL	46/47XL



Art.-No.	Size
94-05041	40/41
94-05243	42/43
94-05445	44/45
94-05647	46/47



**HIP WADERS MJ9504**

WITH RUBBER SOLE

Robust, smooth and light.

Material: Wading boots nylon, PVC coated; Sole rubber

Art.-No.	Size
95-04540	40
95-04541	41
95-04542	42
95-04543	43
95-04544	44
95-04545	45
95-04546	46



**CHEST WADERS MJ9507**

WITH CHEST POCKET

Super lightweight waders with chest pocket in excellent quality.

Material: Waders nylon, PVC coated; Sole rubber; Bag nylon, PVC coated



Art.-No.	Size
95-07439	39
95-07440	40
95-07441	41
95-07442	42
95-07443	43
95-07444	44
95-07445	45
95-07446	46



**CORMORAN**